



AXIS 2110 Network Camera



Your Virtual Eye!

User's Guide R1.0

About This Document

This document is intended for administrators and users of the AXIS 2110 Network Camera, and is applicable for software release 2.13. Although many of the operational aspects of the product are described in the on-line help, this guide does contain information for configuring, managing and using the unit in your networking environment, as well as a general overview of the product functionality.

Readers are recommended to use this document as a supplement to the Wizards and other online information available via the Web-based interface. Later versions of this document will be posted to the Axis Website, as required.

Safety Notices

Please observe all safety markings when using this product. **Caution!** - Potential hazard that can damage the product.

Important! - Potential hazard that can seriously impair operation.

Do not proceed beyond any of the above notices until you have fully understood the implications.

Legal Considerations

Camera surveillance can be prohibited by laws that vary from country to country. Check the laws in your local region before using the AXIS 2110 for surveillance.

Electromagnetic Compatibility (EMC)

USA - This equipment generates, uses, and can radiate radio frequency energy and if not installed and used in accordance with the instruction manual, may cause interference to radio communications. It has been tested and found to comply with the limits for a Class A computing device pursuant to Subpart B of Part 15 of FCC rules, which are designed to provide reasonable protection against such interference when operated in a commercial environment. Operation of this equipment in a residential area is likely to cause interference, in which case the user at his/her own expense will be required to take whatever measures may be necessary to correct the interference. Shielded cables should be used with this unit to ensure compliance with the Class A limits.

Europe  - This digital equipment fulfills the requirements for radiated emission according to limit B of EN55022/1994, and the requirements for immunity according to EN55024/1998 residential, commercial, and light industry.

Liability

Every care has been taken in the preparation of this manual; if you detect any inaccuracies or omissions, please inform your local Axis office. Axis Communications AB cannot be held responsible for any technical or typographical errors and reserves the right to make changes to the product and manuals without prior notice. Axis Communications AB makes no warranty of any kind with regard to the material contained within this document, including, but not limited to, the implied warranties of merchantability and fitness for a particular purpose. Axis Communications AB shall not be liable nor responsible for incidental or consequential damages in connection with the furnishing, performance or use of this material.

Trademark Acknowledgments

Acrobat, Adobe, Boa, Ethernet, IBM, Internet Explorer, LAN Manager, Linux, Macintosh, Microsoft, Netscape Navigator, OS/2, UNIX, Windows, WWW are registered trademarks of the respective holders. Java and all Java-based trademarks and logos are trademarks or registered trademarks of Sun Microsystems, Inc. in the United States and other countries. Axis Communications AB is independent of Sun Microsystems Inc.

Support Services

Should you require any technical assistance, please contact your local dealer. If your questions cannot be answered immediately, your dealer will forward your queries through the appropriate channels to ensure you a rapid response. If you are connected to the Internet, you can obtain on-line manuals, technical support, software updates, application software and general corporate information from www.axis.com.

AXIS 2110 User's Guide

Revision 1.0

Dated: September 2001

Copyright © Axis Communications AB,
1996 - 2001

Table of Contents

Overview	4
Features and Benefits	5
Physical Description	7
Front Panel	7
Rear Panel	8
Assembling Your Camera	9
Checking the Hardware Inventory	9
Fixing the AXIS 2110 to the Mounting Assembly	9
Installing Your Camera on a Network	10
Quick Installation Procedure	10
Checking the Installation From Your Browser	12
Other Methods of Setting the IP Address	13
Notes for Macintosh Users	16
Using Your Camera with a Modem	17
Before You Begin	17
Configuring Your Camera	23
Configuration Using the Wizards	23
The Administration Tools	25
Reinstating the Factory Default Settings	28
Choosing Your Application	29
Networking Applications	29
Modem Applications	34
Appendix A - Lenses and Focusing	39
Manual Focusing	39
Focusing using the Focus Assistant	40
Replacing the Lens	42
Appendix B - Troubleshooting	43
Frequently Asked Questions	43
PINGing Your IP Address	44
Problems, Possible Causes and Remedial Actions	45
Appendix C - Updating the Software	48
Appendix D - The Unit Connectors	49
Appendix E - High Speed Services	54
Appendix F - Technical Specifications	56
Index	57
Glossary of Terms	59

Overview

The AXIS 2110 is a digital TCP/IP network camera that includes all of the required networking connectivity for distributing images or live video over an intranet, or the Internet. With its own built-in Web server, it allows high-quality remote surveillance images to be viewed directly from any browser on the network, and provides full Web-based control of the various management and configuration functions.



The AXIS 2110 can be used in indoor or outdoor environments. In the latter case, the camera must be housed in a suitable outdoor enclosure.

Use the camera for intruder detection, process control, industrial and public surveillance, visual security, image archiving, or any other application requiring remote monitoring.

Designed using an open-network structure, the AXIS 2110 minimizes the need for costly and complex coaxial cabling - to press your installation overheads and provide you with an advanced yet cost-effective network imaging solution. None of the hidden accessories normally associated with digital cameras are required.

Features and Benefits

Easy to Use - The AXIS 2110 is completely independent of any other server and requires no other special hardware or software such as PC frame grabber cards or viewing software. All you need is Netscape Navigator 4.x or above. Alternatively, you can use the Axis ActiveX component for Microsoft Internet Explorer 4.x or above. If your computer does not allow you to use ActiveX components, use the Java Applet instead. The AXIS 2110 has complete plug-and-picture functionality - all you need do is assign a valid IP address.

Simple Installation - Connecting directly to Ethernet or Fast Ethernet networks, the AXIS 2110 is a standalone digital camera that will also connect to your local Internet Service Provider using an external modem. Its Web-based interface features several user-sensitive Wizards that simplify the installation process, and provide for a seamless and automated integration into your networking and application environments.

Open Standards Environment - Supporting TCP/IP, SMTP e-mail, HTTP and other protocols, the AXIS 2110 can be used in mixed environments, such as Windows, UNIX, Macintosh and OS/2. Integrates easily into other WWW/Intranet applications and CGI scripts.

Simple Administration - Configuration and management via the product's own Web-based Administration Tools. Image control, time stamping and text overlays are all accessible from the tools.

Standard Image Format - The AXIS 2110 delivers complete, high-quality pictures in standard JPEG format, which can be viewed using any standard browser.

High Compression and Sensitivity - The fully configurable compression features afforded by the AXIS ARTPEC chip allow a normal quality image to be compressed to around 8 kbytes. Actual file sizes vary according to lighting conditions; although the product works well even in dark environments - right down to 3 lux.

Standard Lens - Standard CS wide-angle lens with rotational focus control. A C-lens can also be used together with a CS-C adaptor. Any other lens conforming to the same standard can also be used.

External Device Connection - Can be used with IR-sensors, switches and alarm relays.

ISP and Modem - The Point to Point Protocol (PPP) support allows you to use your AXIS 2110 remotely over a serial link, just as if it were located on your local network. Initially setting up the unit using a computer connected by the supplied Null Modem cable, you can quickly configure the unit for remote use using an external modem; whereby your video images can even be uploaded to your preferred Internet Service Provider (ISP) to allow global access to your live images from any browser on the Internet. Select any of the supported ISPs in the Web-based Wizards, or use your own ISP as storage for your live images.

Security - The AXIS 2110 includes a self-contained Web server, which means that digital images can be secured like any other Internet host. Data protection is normally implemented by your Network Administrator using the unit's security settings in combination with an organization's Internet firewall. The Administrator can decide whether individuals, groups, the whole company or the whole world may access your camera. The AXIS 2110 supports multi-user password protection.

Network Camera Servers Developer's Pages - The Camera Division at Axis maintains a specialist site for network camera developers. New ideas and tools for software developers are often added. Follow the camera links and check it out at: www.axis.com

Linux Operating System - Including a Boa Web server, the Linux operating system provides a stable platform for open-source development in future releases of the product. In accordance with the *GNU General Public License*, Axis have published the kernel for this product at <http://developer.axis.com/>. Axis would like to thank Paul Phillips, who wrote Boa; and Larry Doolittle, who is now enhancing and maintaining this free software - published at www.boa.org.

AXIS Technology - Axis renowned chipset technology is built upon an open architecture that is streamlined to provide device connectivity independent of any file server. The AXIS 2110 is driven by a powerful AXIS ETRAX 32-bit RISC processor and includes the industry's first dedicated digital video remote monitoring compression chip - the AXIS ARTPEC-1.

Compression and Performance - With an adaptive frame rate dependent on the prevailing lighting conditions, the AXIS 2110 delivers Motion-JPEG images at up to 15 images per second, as well as single JPEG images that feature user-defined compression levels. See also *Picture frequency for Networking Applications*, on page 30.

Complimentary Software -

- AXIS IP Installer - for quick installation of multiple units
- AXIS Camera Control (Axis' ActiveX component software, required for Microsoft Internet Explorer).
- Java Applet for use with Internet Explorer when ActiveX cannot be used.

Physical Description

Read the following information to familiarize yourself with the AXIS 2110, making particular note of where the connectors and indicators are located. This information provides a useful reference during the installation of the product.

Front Panel

● Status Indicator

Used in conjunction with the Focus Assistant, this multi-colored indicator can be configured for use as a local focusing aid (for further details please refer to *Lenses and Focusing*, on page 39). Under normal conditions however, this indicator shows the operational status of the camera, as described below:

- green - the indicator flashes briefly and momentarily displays orange during the start-up and self-test routines. The indicator then displays green to indicate a healthy unit status.
- red - the indicator will display red only if a problem with the AXIS 2110 has occurred. Refer to *Appendix B - Troubleshooting*.

Note: The Status indicator also displays orange when re-setting to the factory default settings, as described in *Reinstating the Factory Default Settings*, on page 28.

● Control Button

Located to the left of the lens assembly; this button is recessed within the product casing. Using a suitably pointed object, press this button to restore the factory default settings as described in *Reinstating the Factory Default Settings*, on page 28; or enable the Focus Assistant, as described in *Lenses and Focusing*, on page 39.



● Lens Assembly

Manual iris Tele/wide zoom lens with rotational focus control.

The supplied lens is removable and can be replaced with any standard C/CS lens.

● Serial Number

Located on the underside label of the AXIS 2110, the serial number is identical to the Ethernet address of the unit.

Important!

Although the AXIS 2110 is intended for outdoor and indoor use, it is important to note that the charged coupled device (CCD) in the camera can become permanently damaged if it is exposed to too much direct sunlight, or halogen light. Therefore, it is important that the Adjustment Ring is not set fully open when installing the camera in bright light conditions. The Axis warranty does not cover CCD damage caused by prolonged exposure to strong light.

Rear Panel

Network Connector ●

The AXIS 2110 is designed for 10 Mbps Ethernet and 100 Mbps Fast Ethernet networks and connects to the network via a twisted pair category 5 cable (10baseT and 100baseTX) terminated using a standard RJ-45 connector. Supporting NWAY, the AXIS 2110 detects the speed of the local network segment and varies the speed of data communication accordingly, between 10 Mbps and 100 Mbps.

● Network Indicator

After completion of the startup and self test routines, this multi-colored indicator flashes independently, as follows:

- yellow - activity on a 10Mbps network
- green - activity on a 100Mbps network
- red - no physical connection to the network

● Power Indicator

Normally lit when power is applied. If it is not lit, or it flashes, there is a problem with the AXIS 2110 external power source.

● Power Supply Connector

A single Jack socket (PS-D) for connection of AXIS 2110 power supply. The terminal block connector provides an auxiliary connection point for AC or DC power to the unit.

I/O Connector ●

Provides the physical interface to a digital output, and a single digital photo-coupled input that is used for connecting a variety of external alarm devices to the AXIS 2110; including, IR-sensors, switches and alarm relays. In combination with the configurable alarm facilities, you can quickly develop a variety of security applications that are triggered on time - or alarm based - events. The connector can also be utilized as an alternative connection point for DC supply to the unit.

● RS-232 Serial Connector

Single 9-pin D-sub connector providing the RS-232 serial interface dedicated for modem connection.



Note: The power supply supplied with your AXIS 2110 is country specific. Please check that the type you are using is correct. See *Checking the Hardware Inventory*, on page 9.

Assembling Your Camera

The information provided in this section will help you unpack and assemble your product. You will then be ready to proceed with the installation and configuration of the product into your application environment, as described in the following sections of this document.

Checking the Hardware Inventory

Unpack and check all the items against the itemized list below. You should contact your dealer immediately if you find anything is missing or damaged.

Hardware	Model Variants	Part Number
Digital Camera	AXIS 2110	0146-001-01
Null Modem Cable	-	16954
Mounting Assembly	-	15104
Power Supply (PS-D)	Europe	14233
	UK	14234
	Australia	14255
	USA	14253
	Japan	14254
PS-D Extension Cable	3.3 meter	15187
Printed Materials	AXIS 2110 Installation Guide 1.0 (or later)	18819
	AXIS Warranty	18489

Fixing the AXIS 2110 to the Mounting Assembly

Caution!

Although the AXIS 2110 is intended for outdoor and indoor use, it is important to note that the charged coupled device (CCD) in the camera can become permanently damaged if it is exposed to too much direct sunlight, or halogen light. Therefore, it is important that the Adjustment Ring is not set fully open when installing the camera in bright light conditions. The Axis warranty does not cover CCD damage caused by prolonged exposure to strong light.

The mounting assembly supplied with your AXIS 2110 features a screw head that attaches to the underside of the product. Fasten the AXIS 2110 to the mounting assembly and position it appropriately for your application. The three holes in the base unit allow the product to be securely fastened to any wall or ceiling.



Note: If you need to mount your camera upside-down, the AXIS 2110 can be easily configured to flip images through 180°.

Installing Your Camera on a Network

- Macintosh users - Please refer to *Notes for Macintosh Users*, on page 16.
- Easy installation - Use The AXIS IP Installer. See *Using the AXIS IP Installer*, on page 13.
- Quick installation- Follow the instructions below to install the AXIS 2110 on an Ethernet network.

Quick Installation Procedure

Follow the instructions below to quickly install the AXIS 2110 onto an Ethernet network:

Important!

- To install the AXIS 2110 to a modem, see *Using Your Camera with a Modem*, on page 17
- Do not use the default IP address featured in the following examples when installing your AXIS 2110. Acquire an unused IP address from your Network Administrator.
- Server Privileges: Although no special privileges are required for Windows 95/98, you do need *Administrator* privileges for Windows NT/2000, and *Root* privileges on UNIX.

❶ Note the Serial number

Note the serial number on the underside of the unit. You need to know this to set the IP address:

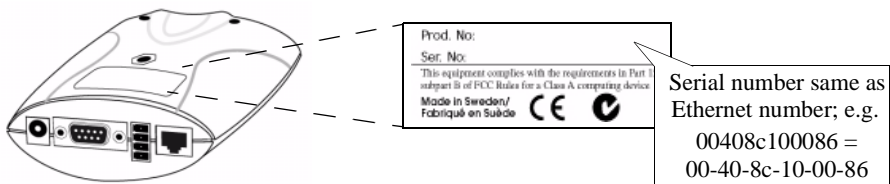

❷ Assign an IP Address

Using an appropriate method for your operating system, you can assign your AXIS 2110 with an IP Address from a computer on your network using the ARP command, as follows:

Windows 95/98 & NT/2000 only - Start a DOS window and type these commands:

Syntax:

```
arp -s <Camera IP address> <Ethernet address> <myPC IP address>
ping -t <Camera IP address>
```

Example:

```
arp -s 172.21.1.200 00-40-8c-10-00-86 172.21.1.193
ping -t 172.21.1.200
```

UNIX only - Type these commands in your command line:

Syntax:

```
arp -s <IP address> <Ethernet address> temp
ping <IP address>
```

Example:

```
arp -s 172.21.1.200 00:40:8c:10:00:86 temp
ping 172.21.1.200
```

You will now see the message 'Request timed out...', repeatedly returned in the window.

- Notes:**
- In Windows you can find out the IP address of your workstation by running **winiipcfg** (Win 95/98) or **ipconfig** (Win NT/2000) from the command line.
 - See also *Other Methods of Setting the IP Address*, on page 13.

3 Connect an Ethernet cable

Connect an Ethernet cable to your AXIS 2110 and attach it to the network.

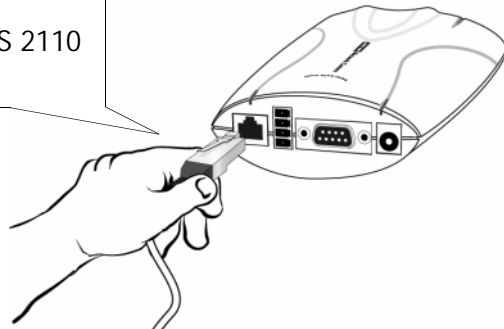

4 Attach the external Power Supply

Attach the power cable to the unit and connect it to your local mains supply.

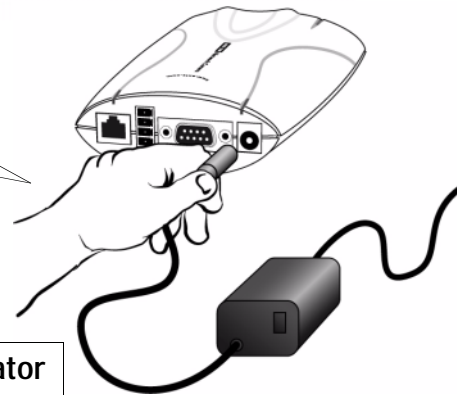

5 Wait for ARP reply and check Network indicator

Approximately 10-15 seconds after connecting the power supply, the message 'Reply from 172.21.1.200...' - or similar, is returned in the window. Ensure that the Power Indicator is permanently lit and that the Network Indicator flashes intermittently.

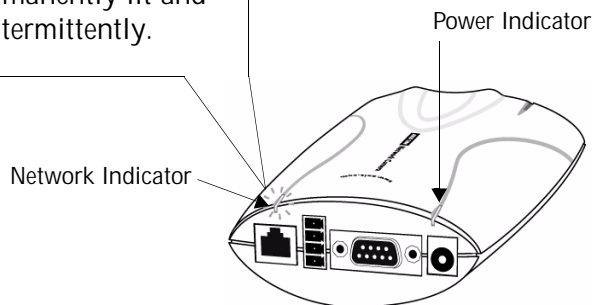

6 Exit ping and check the installation

The installation is now complete, and you are ready to access the AXIS 2110 from your browser, as described in the next section.

Checking the Installation From Your Browser

Having completed the installation, you should then check the connection between the AXIS 2110 and the network, as follows:

1. Start your browser (see note below) and enter the name or IP address of your camera:

Example!

http://10.11.12.13/

The Home Page for your AXIS 2110 is now displayed:

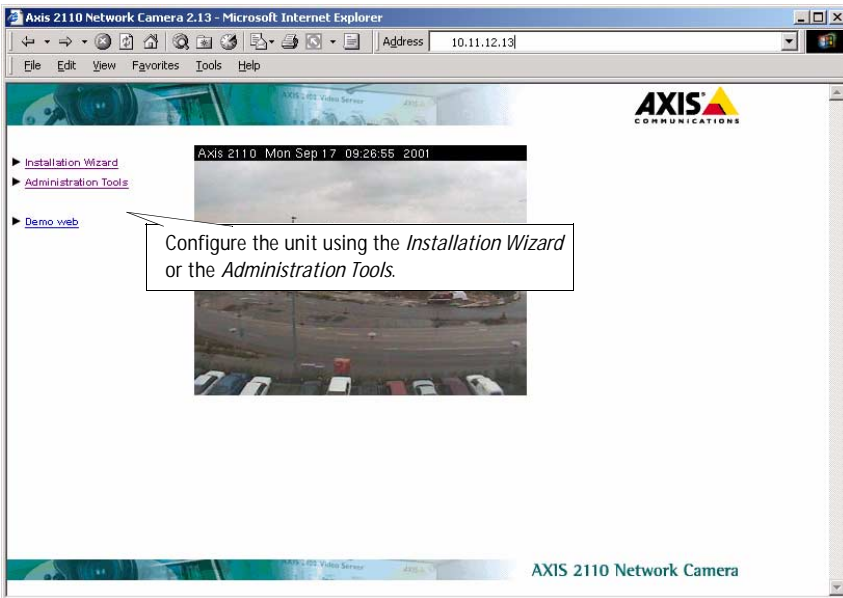

2. Continue the setup and configure your application using the **Installation Wizard** or **Administration Tools**, as described in *Configuring Your Camera*, on page 23.

Important!

- To enable the updating of images in Microsoft Internet Explorer, you must set your browser to allow ActiveX controls, and perform a once-only installation of the Axis ActiveX component onto your workstation. However, if your computer environment restricts the installation of additional software, you can alternatively set your AXIS 2110 to use a Java applet for updating the images. This is done from Image settings.
- When accessing the Admin Tools for the first time in a browser, you will not be prompted for a username or password. You will be assumed to be the Administrator and will automatically be logged on as such, with the username root and the default password pass. This root password must, however, be changed as soon as possible, to enable the security function. Also, all Axis products are shipped with the same password as default. For more information, refer to *System Security*, on page 27.

Other Methods of Setting the IP Address

In addition to the ARP command described earlier, you can set the IP address using an appropriate method for your operating system from the table below:

Important!

Ethernet Address: The AXIS 2110 is pre-configured with a unique Ethernet Address based upon the serial number printed on the label on the underside of the unit; where the serial number typically follows the format 00-40-8c-xx-yy-zz. You must know the Ethernet address to complete the installation.

Method	Operating Systems	Refer to...
AXIS IP Installer	Windows 95/98 and NT/2000	<i>Using the AXIS IP Installer</i> , on page 13.
DHCP	Most	<i>DHCP</i> , on page 14.
BOOTP Requiring a BOOTP daemon on your system, this method operates over the entire network. A request to an active daemon initiates a search of the boot table to find an entry matching the unit's Ethernet address. The daemon downloads the IP address to the device if a match is found.	UNIX	<i>Using BOOTP in UNIX</i> , on page 15.

Using the AXIS IP Installer

The AXIS IP Installer is a Windows 95/98 & NT/2000 program that is ideal for setting the IP addresses for *multiple* Axis' networking products on your network. Also allowing you to conveniently access the home Web page of any Axis ThinServer device connected to your network, this freely distributed software is available for download from the Axis Website at www.axis.com.

Installing the AXIS IP Installer:

1. Download the latest AXIS IP Installer software onto your desktop and run the *Setup_IPInstaller.exe* program to start the installation.
2. The **AXIS IP Installer - Setup** dialog is displayed on the screen.
3. Follow the instructions as they appear on the screen.
4. Click **Finish** to complete the installation.

Setting the IP Address with the AXIS IP Installer

1. Start the **AXIS IP Installer**. The **AXIS IP Installer** dialog is displayed on the screen.

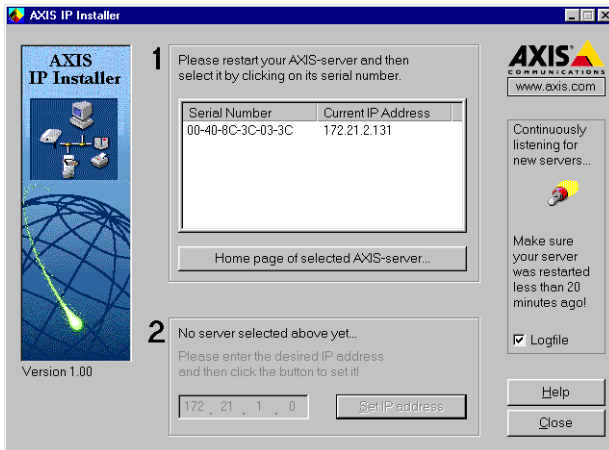

2. Restart your AXIS 2110 by disconnecting the power supply and then reconnecting it.
3. Select the serial number of your AXIS 2110 from the list. The serial number is identical to the unit's Ethernet address, found on the underneath of the unit.
4. Enter the desired IP address. Click **Set IP address**. The IP address will now be set.
5. To access the home page of the AXIS 2110, click **Home page of selected Axis-server...** You can now configure the AXIS 2110 according to your requirements.
6. Click **Close** to exit the program.

For more help during the installation of the IP address, click **Help** or press **F1**.

DHCP

DHCP (Dynamic Host Configuration Protocol) is a protocol that lets network administrators centrally manage and automate the assignment of Internet Protocol (IP) addresses in an organization's network.

Important!

DHCP should only be enabled if you know which IP address the AXIS 2110 will get from the DHCP server, or if your version of DHCP can update a DNS server, which then allows you to access the AXIS 2110 by name. If DHCP is enabled and you cannot access the unit, you may have to reset it to the factory default settings (see page 28) and then perform the installation again (see page 10).

Using BOOTP in UNIX

Follow these steps to use the BOOTP method:

1. Append the following entry to your boot table. This is typically done using the file `/etc/bootptab`:

```

<host name>:ht=<hardware type>;vm=<vendor magic>;\
:ha=<hardware address>;ip=<IP address>;\
:sm=<subnet mask>;gw=<gateway field>
```

where:

- ht = ether
- vm = rfc1048
- ha = The Ethernet address of the AXIS 2110
- ip = The IP address of the AXIS 2110
- sm = The subnet mask
- gw = The default router address

Example!

```

mycam:ht=ether;vm=rfc1048;\
:ha=00408c100086;ip=172.21.1.200;\
:sm=255.255.255.0;gw=172.21.1.1
```

2. If necessary, update your host table and alias name databases according to the requirements of your system.
3. If it is not already running, start the BOOTP daemon. This is typically done using the command `bootpd`.
4. Restart the AXIS 2110 to download the IP address, default router address, and subnet mask.

Mapping a Host Name to the IP Address

If you are using host names, you can also map a unique host name to the acquired IP address. Refer to your system manuals or Network Administrator for instructions on how to perform the name mapping on your particular system.

Notes for Macintosh Users

The AXIS 2110 supports TCP/IP over Ethernet, or PPP Modem dial-up. You must use TCP/IP on your Macintosh network, as there is no support for AppleTalk.

When using the AXIS 2110 on a Macintosh, please observe the following points:

- The camera has a default IP address of 192.36.253.80.
- Assign a temporary IP address in the same subnet (e.g. 192.36.253.81) to a Mac workstation and then connect to the camera.
- Run the Installation wizard and set the desired IP address for the camera.
- Also reset the correct IP address for the Macintosh workstation.
- Changing the IP address for a Macintosh is simple and there is no need to reboot.

Currently there are limitations in the ActiveX Support in Internet Explorer running on the Macintosh. This results in problems when viewing live moving images. The recommended solution for viewing Axis cameras on the Macintosh is to use Netscape.

Using Your Camera with a Modem

The information in this section describes how to set up the AXIS 2110 for use with a serial modem for transmitting images over a standard Dial-up connection.

Before You Begin

Before you can set up and access a modem-connected AXIS 2110 from a browser, you must first create a local connection to it. This connection is only required for the initial setup, and can be created using the network or the supplied Null Modem Cable.

Using the Network

The easiest and best way to configure the camera for use with a modem is to first install it onto a local network, if available. See *Installing Your Camera on a Network*, on page 10 for more information. You can then use the Wizards and Administration tools to configure the modem connection and the application.

Using the Null Modem Cable

When there is no network available, the alternative is to connect a local computer to the AXIS 2110 using the supplied *Null Modem Cable*. You then create a Dial-up connection and establish the basic settings, using the Wizards and Administration Tools. See the following pages for more information. This type of connection is only a temporary solution that provides initial access to the camera. Once you have set up the camera for modem access, then all configuration can be done via the modem connection instead and you will not need to use the cable again.

Important!

Please note that the Null Modem Cable is only intended for the initial configuration of modem applications when there is no Ethernet Network available. It is not possible to use the cable as a serial connection for using the AXIS 2110 as a "PC webcam".

Quick Start For Advanced Users:

Follow these abbreviated instructions if you are experienced with Windows Dial-up Networking:

1. Connect the camera to the Ethernet Network if available, and use a browser to open the IP address you set for your AXIS 2110. Proceed to step 5. If no network is available, use the Null Modem Cable and proceed to step 2.

2. Set up an existing session to 115 200bps, using the physical COM port to which you have connected your AXIS 2110.
3. Log on with user ID *root* and password *pass*. The phone number you enter are irrelevant at log on and you should thus use dummy numbers for completing these dialogs.
4. Start your Dial-up Networking session and enter any URL: the AXIS 2110 emulates a DNS server and will respond to this regardless.
5. Start the Installation Wizard and Administration Tools to further configure the product, as described in *Configuring Your Camera*, on page 23.

Connecting Your Computer Using the Null Modem Cable

Important!

- The information and screen examples shown in this section are from Windows NT. Although similar to the Dial-up implementations in Windows 95, 98, and 2000, small differences in the dialog instructions for other operating systems should be expected. Refer to your system information for further information on creating a Dial-up modem connection if you are using any other operating system.
- Windows Dial-up Networking and TCP/IP must be correctly installed prior to commencing with the modem cable connection. Detailed information on how to check this is provided in the Microsoft Windows Help.

Follow the steps below to configure a serial modem connection for your AXIS 2110:

1 Connect the supplied Null Modem Cable between the COM port on the AXIS 2110 and the serial port on your computer.

2 Connect the power supply to the camera and check that the Power Indicator is lit.

3 From the Start menu, open the Control Panel and double click the Modems icon.

4 If a Standard Modem is already set up and displayed in the Modem Properties dialog (see right) you should proceed directly to step 8.

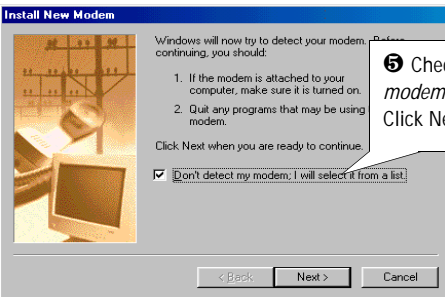
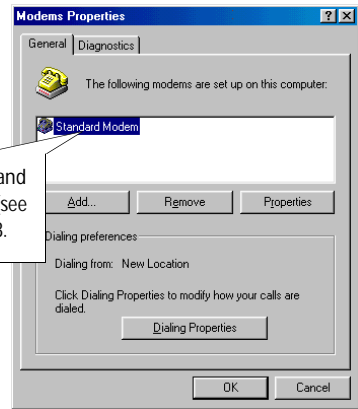

5 Check the box: *Don't detect my modem, I will select it from a list.* Click Next>.

6 Select the Standard 28800 modem from the displayed list of modems. Click Next>.

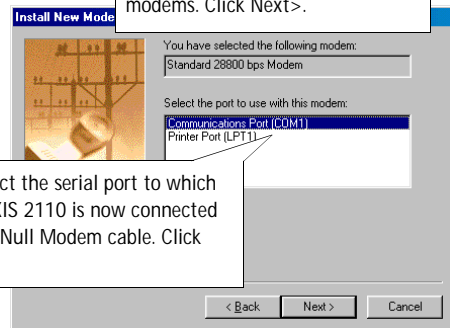

7 Select the serial port to which your AXIS 2110 is now connected via the Null Modem cable. Click Next>.

8 A Standard 28800 modem connection is now available for the AXIS 2110. Click Finish to close the *Install New Modem Wizard*.

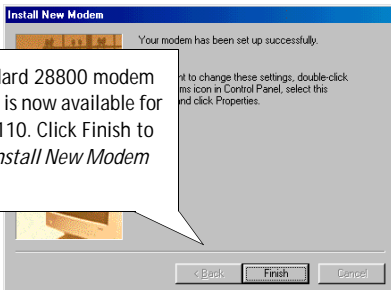

9 Click the Properties button to finally check that the displayed Communications Port is set correctly; that is, set to the same port as you have connected the AXIS 2110. Click OK.

10 Click Close.

Creating a Dial-up Networking Connection...

To create a Dial-up networking connection to your AXIS 2110, follow these steps:

- 1 Double-click *My Computer* and then double-click the *Dial-Up Networking* icon.
- 2 Double-click the *Make New Connection* icon.
- 3 Provide the connection with a name (*AxisCamera* is the name used in the subsequent examples).
- 4 From the drop down list, select the *Standard Modem* previously created for the *AXIS 2110* as the selected device. Click *Configure...*
- 5 To significantly improve the performance of your *AXIS 2110* when using the *Null-Modem* cable, set the *Maximum Speed* to *115200*.
- 6 Click *OK* to return to the *Make New Connection* dialog. Click *Next >*.
- 7 The telephone numbers requested in the following dialog are not required for use in the logical connection to your camera. To bypass the wizard error correction, simply enter any dummy number into the *Area code*, *Telephone number* and *Country code* fields. Click *Next >*.
- 8 You have now successfully created your dedicated *Dial-Up Networking* connection for your *AXIS 2110*. Click *Finish*.

The *Dial-up Network* connection is displayed. You are now ready to refine the *Dial-up networking* properties, as described in the next section.

Refining the Dial-up Networking Properties...

Having created the Dial-up connection for your AXIS 2110, follow the steps below to refine the connection properties:

❶ From the Dial-up Networking dialog, right click the dedicated Dial-up connection previously created for you camera (*AxisCamera* was the connection created used in this and previous examples). Select Properties.

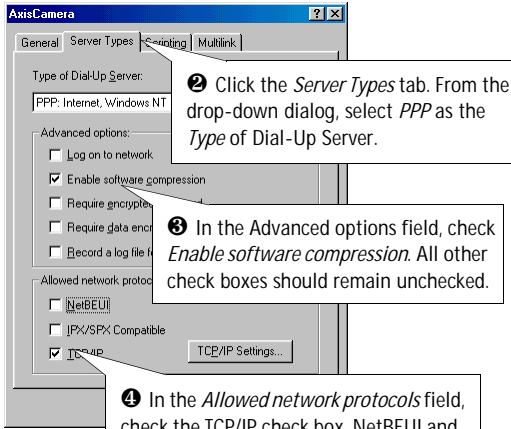

❷ Click the *Server Types* tab. From the drop-down dialog, select *PPP* as the *Type of Dial-Up Server*.

❸ In the *Advanced options* field, check *Enable software compression*. All other check boxes should remain unchecked.

❹ In the *Allowed network protocols* field, check the *TCP/IP* check box. *NetBEUI* and *IPX/SPX Compatible* check boxes should remain unchecked.

❺ Click *TCP/IP settings* and then check the *Server assigned IP address*, and *Server assigned name server addresses* radio buttons.

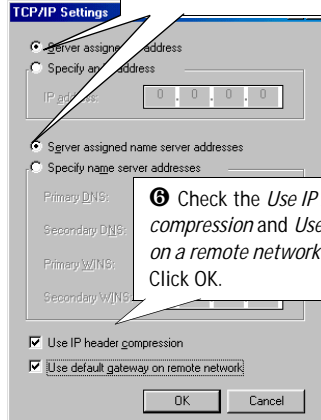

❻ Check the *Use IP header compression* and *Use default gateway on a remote network* check boxes. Click *OK*.

❼ Click the *Scripting* tab and ensure that the *Start terminal screen minimized* check box is checked. Click *OK* to exit *Dial-Up Networking Properties*.

Initiating the Dial-up Connection

Important!

If you have problems connecting via the Null Modem Cable, go back through the instructions provided above and check that the connection is correctly configured.

❶ Double-click *My Computer* and then double click the *Dial-Up Networking* dialog.

❷ Double-click the Dial-Up connection icon that was previously created for your AXIS 2110. *AxisCamera* was used in this and previous examples.

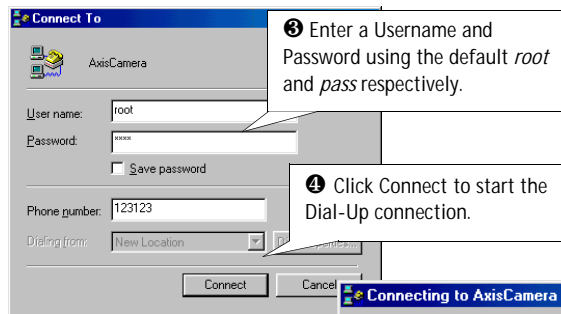

❸ Enter a Username and Password using the default *root* and *pass* respectively.

❹ Click *Connect* to start the Dial-Up connection.

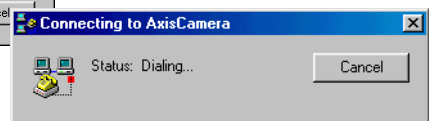

Verifying the Modem Connection

Having initiated your Dial-up connection, as described above, you can quickly check the connection by accessing the AXIS 2110 with a standard Web browser; such as Netscape or Internet Explorer as follows:

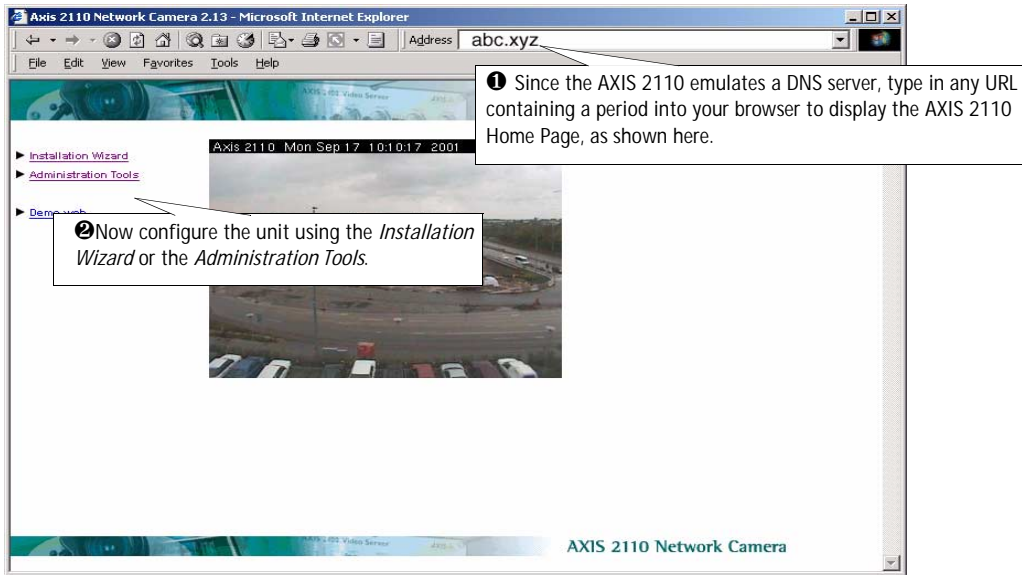

Configuring Your Camera

Important!

- Before configuring the camera it must have been successfully installed. It is assumed that you have decided which application you wish to develop and that you have subsequently installed your camera prior to commencing with this section. If not, please refer to *Choosing Your Application*, on page 29 and the respective sections for your installation: *Installing Your Camera on a Network*, on page 10; or *Using Your Camera with a Modem*, on page 17.
- Check your Internet Options/Security settings and ensure that scripting is enabled. Javascript must be enabled in your browser for the AXIS 2110 Web-based interface to work.
- When accessing the Administrator Tools for the first time during a browser session, you will not be prompted for your username and password. You will be assumed to be the Administrator and will be automatically logged on as such, using the username root and the default password pass. Please change the the root password as soon as possible, as only then will security be enabled in your product. All Axis products are shipped with the same password as default. For further information, refer to *System Security*, on page 27.

The AXIS 2110 is configured and integrated into your application environment using the available *Wizards*, or the Web-based *Administration Tools*.

This section provides detailed information on how to use the *Installation and Application Wizards* for creating your application, and a general overview of the supported *Administration Tools* used for refining the product configuration for use in your application environment.

Note: On-line help  is available from most pages within the AXIS 2110 Web interface. Containing comprehensive details on all product parameters, this information is your first point of reference when configuring and managing the unit, and is a particularly useful reference when resolving any administration queries. The help system is stored internally in the AXIS 2110.

Configuration Using the Wizards

Having decided on the application you wish to develop and having installed your AXIS 2110 accordingly, the unit is now connected directly to a local area network, or to a local PC using the supplied *Null Modem Cable*. For speedy development of your application, the AXIS 2110 provides two easy-to-use Wizards that are recommended for both novice and advanced users alike: the *Installation Wizard* and the *Application Wizard*. Depending on your choice of application, you can run each of these Wizards either consecutively or independently of one another.

Installation Wizard Overview

The **Installation Wizard** provides a quick and easy method with which to define the *System, Security, Image* and *Layout* settings for your application - as defined in the *Administration Tools Overview*, on page 26.

Starting the Installation Wizard

1. With reference to the information provided in the On-line Help , double-click the **Installation Wizard** from the **Home Page** and follow the Wizard to complete your configuration.
2. Click the **Finish** button to save the defined application settings to the camera.

Tip!

Having used the Installation Wizard to initially configure your application, refer to the on-line Help and use the Administration Tools to refine the application to meet your specific needs.

Application Wizard Overview

The **Application Wizard** can be started from the final page of the **Installation Wizard**, or independently from the **Administration Tools**. It provides a quick and easy way of defining the settings for your application - as defined in the *Administration Tools Overview*, on page 26.

Starting the Application Wizard

1. With reference to the information provided in the On-line Help, click the **Application Wizard** link from within the **Administration Tools** to start the Wizard.
2. Click the **Finish** button to save the defined application settings to the camera.

The Administration Tools

The Web-based **Administration Tools** are used for configuring and managing your AXIS 2110. After initially setting up the AXIS 2110 with the **Installation Wizard**, these tools are ideal for use by more advanced users when reviewing and refining the configuration.

Accessing the Tools

Follow the instructions below to access the **Administration Tools** from a standard browser:

1. Start the Web browser and enter the name or Internet address of the AXIS 2110 (or any DNS name if you are accessing the unit via the Null Modem Cable) in the location/address field.

Example!

http://10.11.12.13

2. The AXIS 2110 Home page is now displayed. Click **Administration Tools**.

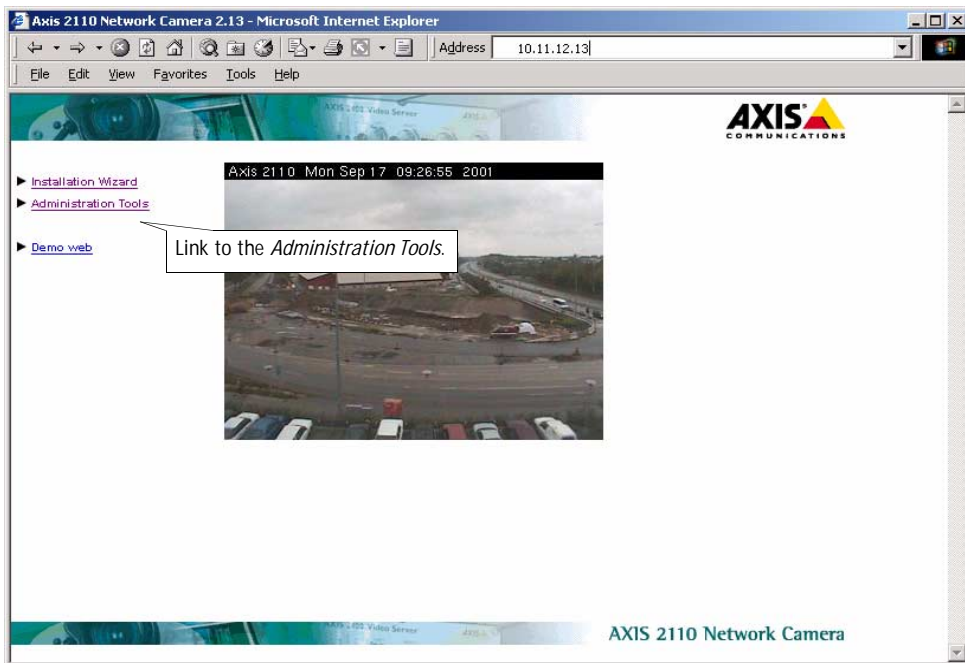

Note: When entering these pages for the first time in a browser, you will not be prompted for a *username* or *password*. However, to enable the security function you must change the default password *pass* as soon as possible. Log on as *root* with the default password and then change the password. To complete the operation, close your browser and then reopen it.

3. The **Administration Tools** are now presented as links in the margin of the Administration Page. Simply click the relevant link for the parameters you want to configure. As an *Administrator*, you configure and modify the system directly from this page.

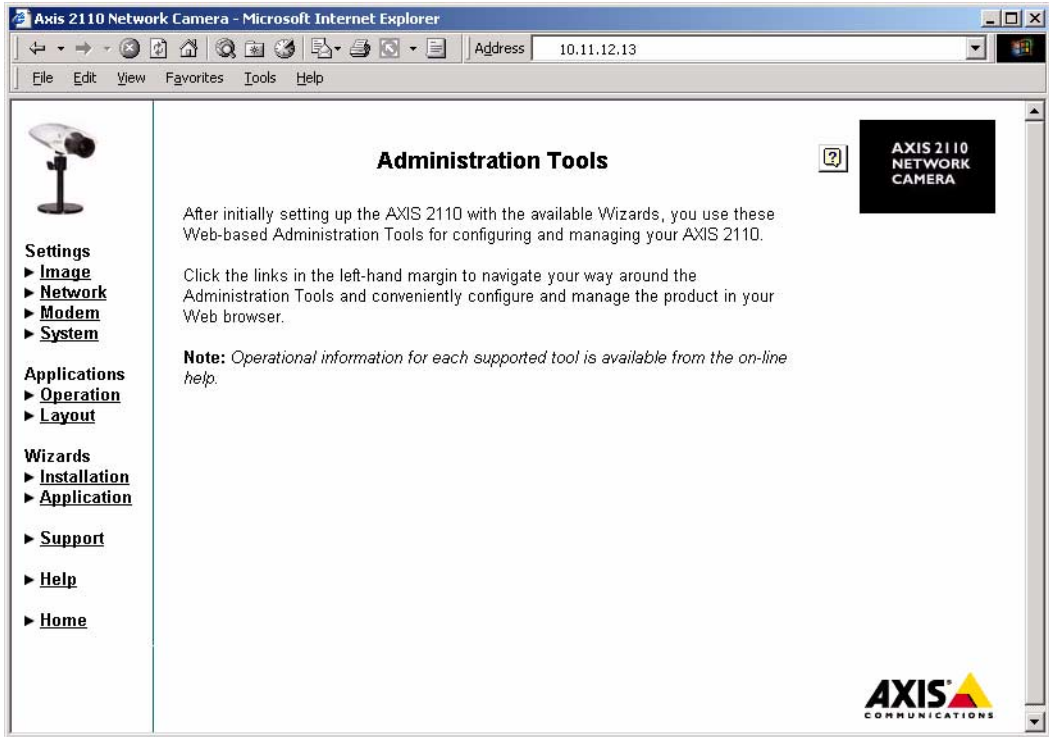

Tools Overview

The table below provides an overview of the **Administration Tools**:

Settings	Sub-settings	Description
Image	General	Define image attributes: appearance, tuning, headers, default viewer, etc.
	Focus	Enable the Focus Assistant and use it to focus the camera.
Network	TCP/IP	Configure the TCP/IP network, enable DHCP and BOOTP.
	SMTP	Make settings for SMTP E-mail.
Modem	General	Configure the general communication settings for the modem.
	ISP	Make the settings for the connection to your Internet Service Provider.
System	Date & Time	Set the Date and Time in the camera.
	Users	Add and delete users, and change passwords and authorizations.
Applications	Sub-settings	Description
Operation	Selection	Choose to run your AXIS 2110 in Sequential, Alarm or passive Mode.
	Scheduler	Set the times for recording images.
	Upload	Make the settings for how images are uploaded.
Layout	General	Determine the Layout for the Web page in which your images will appear: customize the page to your own design and include your own logos, links and title texts, and enable or disable specific function buttons.

Wizards	Description
Installation Wizard	The Installation Wizard guides you through the settings for: Security (users and passwords), Date and Time, Images, The Focus Assistant and the settings for Network or Modem connection. These settings can also be made individually in the tools described above.
Application Wizard	The Application Wizard helps you set up applications for uploading images to a designated destination, Using this Wizard you can; configure images to upload continuously or only when an event occurs, configure the alarm buffer, set the image frequency, set the times for uploading images, send the images to an ftp-server or via e-mail, etc.
Support & Help	Description
Support	General help, view the Release Notes, view the Parameters and Log File, etc. From here you can also restart the unit and/or reinstate the default factory settings, should this become necessary.
Help	Opens the on-line help function.
Home	Links directly to the Home Page of your application.

System Security

To prevent unauthorized use, the AXIS 2110 supports multi-user password protection and access is restricted to defined *users* **only**. The system *Administrator(s)* has exclusive access to the camera's *Administration Tools* and can determine the registration, and access rights for all *users*.

User Access Rights

As an *Administrator*, click **System** and then **Users** to perform any of the following tasks:

- define or edit the **administrator (root) password**
 - define, add and delete **user names and passwords**
 - assign individual access rights to a selected user, where each user is given one or all of the following levels of access:
 - **Admin:** a user granted *Admin rights* has exclusive access to the camera's *Administration Tools* and can consequently determine the registration of all *users*.
 - **Dial-in:** provides the user with dial-in modem access to the AXIS 2110 only.
 - **View:** provides the lowest level of access, which allows the user to view the images only.
- Adding at least one such user will disallow anonymous users.

Important!

- The Administrator's default username and password (set to *root* and *pass*) can be used for logging in to the unit for the first time, but the default password must be changed to enable the camera's security functions. All Axis products are shipped with the same password as default.
- By default, the AXIS 2110 is set for anonymous user access, which means that anybody on the Internet/intranet can view the video images from a Web browser. To restrict open access, simply register a single authorized user with viewing rights. This effectively revokes the anonymous user service and restricts camera access to specified users. If the anonymous user service is satisfactory for your application, simply do not add any other users.

Reinstating the Factory Default Settings

In certain circumstances, it may be necessary to reinstate the **Factory Default** settings for your AXIS 2110. This is performed by clicking the **Support** link in the **Administration Tools** and then selecting **Restart/Reset**, *or* by pressing the **Control Button**. Follow the instructions below to reinstate the product factory default settings using the Control button:

1. Switch off the AXIS 2110 by disconnecting the power cable.
2. Press and keep the Control Button pressed, and then reconnect the power supply cable.
3. Keep the Control Button pressed until the Status Indicator displays *yellow* (note that this may take up to 15 seconds), then release the button. When the Status Indicator displays *green* (which can take up to 1 minute) the AXIS 2110 will then have been reset to the original factory default settings.

- Notes:**
- Reinstating the original default settings will cause all parameters (including the IP address) to be reset.
 - Refer to *Installing Your Camera on a Network*, on page 10, for information on how to set the camera's IP address.

Choosing Your Application

The AXIS 2110 can be used in a wide variety of applications. Installing directly onto an Ethernet network or via a V.90-compatible modem, the product is completely independent and requires no additional software on your viewing desktop. Crisp live images are available directly in your browser as soon as the product is installed, and your application can be further developed using the camera's easy-to-use *Wizards* or *Administration Tools*.

Not to be regarded as a comprehensive catalog of possible applications, this section describes several typical applications and includes reference information that will help you prepare for the installation and configuration of the unit.

Networking Applications

If you have access to a local Ethernet connection at your chosen point of installation, you only need to plug the AXIS 2110 onto your LAN/WAN and set the IP Address to instantly view the images from any desktop on your network.

However, the AXIS 2110 offers more than just access to live video images. By using the available *Wizards* to guide you through the process, you can configure the camera for any number of exciting applications, including:

- Viewing images in a custom-designed Web page.
- Uploading images to a remote FTP server on a LAN/WAN network to accommodate a large viewing audience, where a high volume of Web page hits is anticipated.
- Connecting an external alarm device to the AXIS 2110 and uploading pre and/or post alarm images to a target FTP server when an alarm or time-based event occurs; and optionally, sending e-mail messages containing a single image and a link to the camera.

Note: Once the AXIS 2110 is physically connected and installed on your network, you can then access live video from any browser on your network - with no further configuration whatsoever. Whether you are an advanced or novice user, you should use the *Wizards* - available from the camera's *Home Page* - to configure your application. Advanced users can optionally use the Web-based *Administration Tools* to refine their application once the basic configuration has been established using the *Wizards*.

Picture frequency for Networking Applications

When used in a TCP/IP networking environment, the AXIS 2110 delivers up to 15 images/second; where the actual image frequency is typically limited by:

- your browser/computer
- the image size
- the lighting conditions at the point of installation.
- the available network bandwidth
- complexity of detail and color variation within the image

Image Compression Ratios

The file size of a JPEG-compressed image depends upon the actual content of the image. Images containing a lot of detail will generate larger files. Image quality is controlled by the level of compression; high compression yields small files, while low compression maintains higher image quality at the expense of larger files. The table below contains average file sizes in kilobytes, derived from real-life tests:

Resolution	Typical File Sizes (kbytes)			
	At lowest compression	At low compression	At medium compression	At high compression
640 x 480	250 kb	20 kb	13 kb	8 kb
320 x 240	70 kb	8 kb	5 kb	3 kb

Note: Using a modern computer will avoid introducing any unnecessary bottleneck when viewing the images.

Lighting Conditions

Just like any camera, the shutter time of the AXIS 2110 increases in low light conditions to guarantee optimal image quality.

The actual frame rate for your images is affected by the prevailing light conditions in your application environment. Although the AXIS 2110 will produce good quality images right down to 3 Lux, local lighting should ideally be stable at 40 Lux or more to achieve optimal image frequency. Consequently, you can expect a reduced frame rate under low light conditions in your application environment, as shown in the diagram (right).

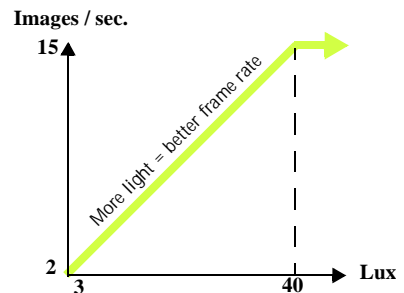

Viewing Images in a Custom-designed Web Page

Simply install the AXIS 2110 directly on your local Ethernet network and complete the *Installation Wizard* to immediately view live video images in your own custom-designed Web page. The Wizard not only helps you define the image format and personalized characteristics of your Web page *Layout*, but even allows you to decide how accessible your product is over the intranet or Internet - you decide in just a few simple steps:

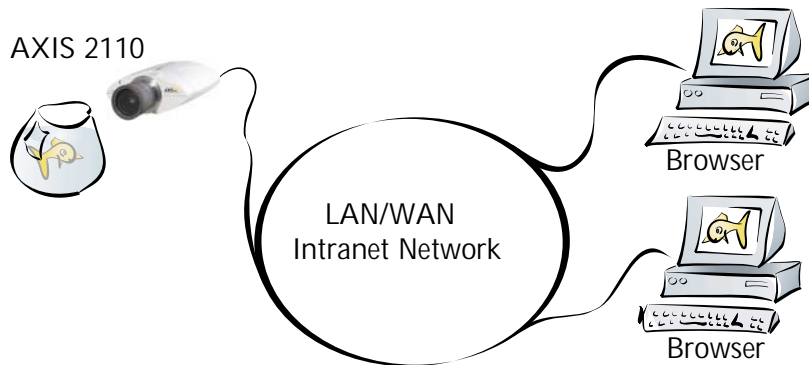

Often used as a Web attraction for enhancing a Web site with live images, this typical application represents the most basic form of network camera configuration. It is ideally suited for *occasionally-visited* sites on both large corporate networks, and SOHO (Small-Office Home-Office) applications where a small network is installed and maintained. If you anticipate a larger audience for your images, you should consider configuring your product to upload images to an FTP server on your network, as described in *Sequentially Uploading Images to a Remote FTP Server*, on page 32.

Installation and Configuration Overview

Configure your AXIS 2110 for viewing images over a network as follows:

1. Connect the AXIS 2110 to your local network. Refer to *Installing Your Camera on a Network*, on page 10.
2. Open the **Home Page** in your browser and start the **Installation Wizard**. Complete the Wizard to establish the standard *Security, Date and Time, Image General Layout* and *TCP/IP Network* settings - selecting **Network** as your chosen method of connection in the **Modem or Network** dialog. Refer to *Configuring Your Camera*, on page 23.
3. Your application is now complete. Having completed the Wizard, you should now verify the installation by checking that you have full access to both the images and the camera's Web pages in your browser.

Note: You can refine your application using the Web-based Administration Tools.

Sequentially Uploading Images to a Remote FTP Server

Ideal for *busy* Web sites on both large corporate networks, and SOHO (Small-Office Home-Office) applications where a small network is installed and maintained; this application uploads images to a designated FTP server on your network, and is perfect for applications where a large audience is expected.

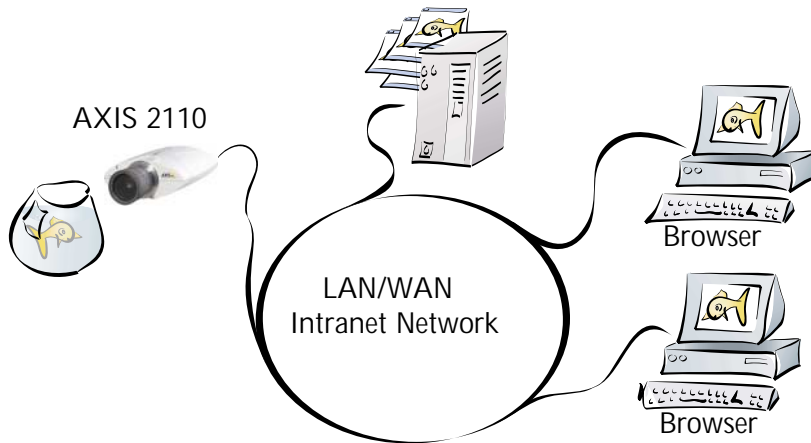

Simply install the AXIS 2110 directly on your local Ethernet network and complete the **Installation** and **Application Wizards** to develop an *active* application that will upload images to a designated FTP server - as a *sequential* stream that is unlimited or restricted to specified time periods. You can organize the times and the frequency at which images are taken and uploaded to the target FTP server. You can also decide to send images sequentially via e-mail messages.

Installation and Configuration Overview

Configure the AXIS 2110 to actively upload images to an FTP server as follows:

1. Connect the AXIS 2110 to your local network. Refer to *Installing Your Camera on a Network*, on page 10.
2. Open the **Home Page** in your browser and start the **Installation Wizard**. Complete the Wizard to establish the standard *Security, Date and Time, Image General Layout* and *TCP/IP Network* settings - selecting **Network** as your chosen method of connection in the **Modem or Network** dialog. Refer to *Configuring Your Camera*, on page 23.
3. Continue the configuration of your product using the **Application Wizard** to define the target FTP server and your preferred mode of operation - choosing *Sequential* mode to create your active application.
4. Having completed the Wizard, you should now verify the configuration by accessing the images stored on the FTP sever from your browser.

Note: You can refine your application using the Web-based Administration Tools.

Uploading Pre and/or Post Alarm Images to a Remote FTP server

The AXIS 2110 is an ideal solution for light indoor surveillance applications. By connecting your chosen external alarm devices to the I/O connector, you can quickly configure the product to upload single images or pre/post alarm image sequences to an FTP server when a time or alarm/input-based event occurs.

Using the available *Wizards*, you organize the times and frequency at which images are taken and uploaded to the target FTP server. You can optionally arrange to send the whole alarm buffer via e-mail.

Installation and Configuration Overview

You configure the AXIS 2110 to upload Pre and/or Post Alarm images, as follows:

1. Connect the AXIS 2110 to your local network. Refer to *Installing Your Camera on a Network*, on page 10.
2. Open the **Home Page** in your browser and start the **Installation Wizard**. Complete the Wizard to establish the standard *Security, Date and Time, Image General Layout* and *TCP/IP Network* settings - selecting **Network** as your chosen method of connection in the **Modem or Network** dialog. Refer to *Configuring Your Camera*, on page 23.
3. Continue the configuration of your product using the **Application Wizard** to define the target FTP server and define your preferred mode of operation - choosing *Alarm Mode* to upload single images, or pre/post alarm image sequences, when a defined alarm or time-based event occurs.
4. Having completed the Wizard, you should now verify the configuration by triggering the defined alarm event and then viewing the uploaded images in your browser.

Note: You can refine your application using the Web-based Administration Tools.

Modem Applications

If a local network connection is not available where you want to use your AXIS 2110, you can alternatively connect your AXIS 2110 to a V.90-compatible modem and quickly configure any number of exciting applications using the Wizards; including:

- Viewing images in a fully custom-designed Web page over a Dial-up modem connection.
- Sequentially uploading images to an ISP (Internet Service Provider) over a Dial-up modem connection and publishing images to the whole Internet community.
- Uploading single or pre/post alarm image sequences to your ISP over a Dial-up modem connection, when an alarm or time-based event occurs; and optionally, sending an e-mail alert containing the whole buffer and a link to the camera.

Important!

- Although the AXIS 2110 is compatible with most V.90-compliant modems, Axis undertakes NO responsibility for V.90 modems that do not work with the product.
- When the AXIS 2110 is dialing out it will obviously not be possible to dial-in to it. If you configure an interval during which the camera will not be dialing out, this will allow you to dial-in and make any necessary changes etc.

Configuration

All modem applications must initially be configured from a browser on a local computer. If available you should always use an Ethernet network for this purpose, even if the actual application will be using a modem. If there is no network available, you can instead use the supplied *Null Modem Cable* to create a direct connection to the AXIS 2110 from the computer. This direct connection is only intended as an alternative for the initial configuration of the modem application when there is no network available. The Null Modem Cable should not be used for any other purpose.

Note: Once the Dial-up modem connection has been created and the AXIS 2110 is physically connected to the modem, you will be able to dial up your AXIS 2110 in exactly the same way as you would your ISP - with no further configuration! Use the *Installation* and *Application Wizards* to establish the basic parameters for your application. Advanced users can use the *Administration Tools* to refine the application after the basic configuration has been established using the Wizards.

Picture Frequency for Modem Applications

When used with a modem, the speed of your communications link will normally determine the image frequency in your browser. A standard image is normally transmitted in 2-5 seconds, although optimal image frequency is achieved by buffering the video stream into internal memory before uploading the recorded images to your ISP or Web server. This is the ideal solution for remote applications connected to external security devices and which require a good flow of images from alarm events.

Proprietary ISP Dial-up Protocols

If your ISP requires you to install any special software before initiating a Dial-up connection, it is likely that your ISP is using proprietary protocols, incompatible with the standard-based AXIS 2110. In these circumstances we recommend that you ask your ISP to provide you with an alternative dial-up facility that allows for standard dial-up networking. Axis does not guarantee the compatibility of this product with any ISP that requires the use of proprietary or non-standard software for the Dial-up connection.

Remote Imaging in a Custom-designed Web Page

The AXIS 2110 can be configured as a standalone application that is completely remote from any network. Ideal for remote surveillance, industrial control, and process monitoring applications, you can quickly configure the AXIS 2110 for a direct installation to your serial modem. This is suitable for a wide range of remote applications that can be viewed from anywhere, from the comfort of the computer at home, or the office.

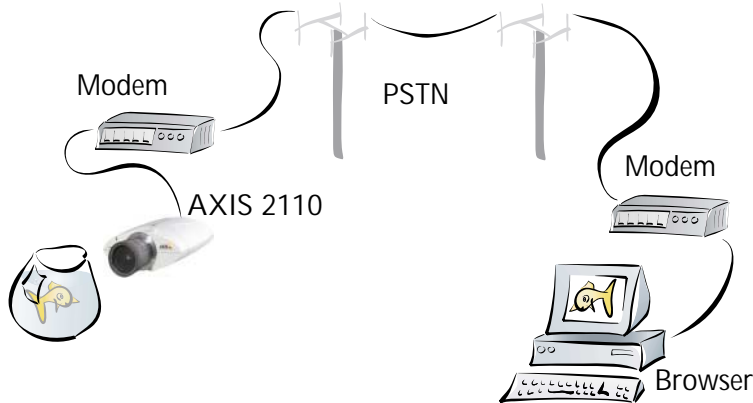

Having established a Dial-up connection for your AXIS 2110, the camera plugs directly into a serial modem to provide immediate access to live video images in your own custom-designed Web page. You access the images and the camera Web pages in exactly the same way as you would dial-up to your ISP.

Installation and Configuration Overview

Configure the AXIS 2110 for viewing images over a Dial-up modem connection as follows:

1. Connect the AXIS 2110 to the network if available. Otherwise, use the supplied *Null Modem Cable*.
2. Install the camera as a modem. See *Using Your Camera with a Modem*, on page 17 for more information.
3. Create a dedicated Dial-up Connection.
4. Refine the Dial-up parameters.
5. Initiate the Dial-up connection.
6. Referring to *Configuring Your Camera*, on page 23, open the **Home Page** in your browser and start the **Installation Wizard**. Complete the Wizard to establish the standard *Security, Date and Time, Image General Layout* and *Modem* settings - selecting **modem** as your chosen method of connection.
7. Disconnect the camera from the network or Null Modem Cable and connect it directly to your modem.
8. Your application is now complete. You should now verify the installation by remotely accessing the AXIS 2110 Web pages from your browser via the connected modem.

- Notes:**
- By configuring the AXIS 2110 to accept incoming calls, you can at any time refine or amend the product configuration via a remote Dial-up connection - or local computer connected via the supplied Null Modem Cable.
 - You can refine your application using the Web-based Administration Tools.

Uploading Images to Your Internet Service Provider

Perfect for Web attractions, remote light surveillance and process control applications; the AXIS 2110 can be quickly configured to dial-out from any remote location and transmit live images to several users, or the whole Internet community - via your preferred Internet Service Provider. Select any of the *Public ISPs* supported in the **Application Wizard**, or alternatively, specify another ISP of your choosing.

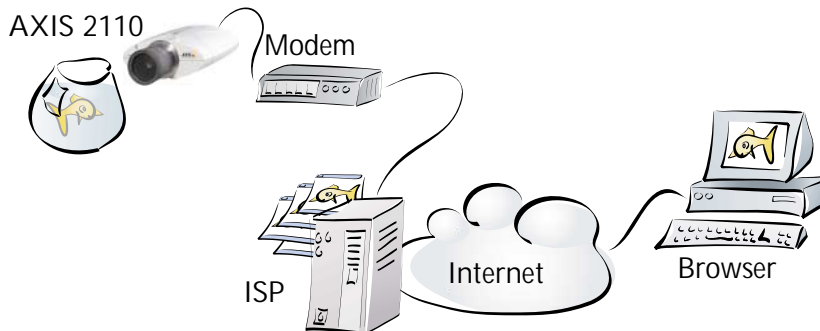

Having established the Dial-up connection for your AXIS 2110, continue your configuration using the **Installation Wizard**, to develop an *active* application that uploads live images to a designated ISP over normal phone lines. Your image files are transmitted as a *sequential* stream, or restricted to specified time periods. You set the times and the frequency at which images are taken and uploaded to the ISP.

Installation and Configuration Overview

Configure the AXIS 2110 to upload images to an Internet Service Provider, as follows:

1. Connect the AXIS 2110 to the network if available. Otherwise, use the supplied *Null Modem Cable*.
2. Install the camera as a modem. See *Using Your Camera with a Modem*, on page 17 for more information.
3. Create a dedicated Dial-up connection.
4. Refine the Dial-up parameters.
5. Initiate the Dial-up connection.
6. Referring to *Configuring Your Camera*, on page 23, open the **Home Page** in your browser and start the **Installation Wizard**. Complete the Wizard to establish the standard *Security, Date and Time, Image General Layout* and *Modem* settings - selecting **modem** as your chosen method of connection.
7. Continue the configuration using the **Application Wizard** to define your preferred ISP and mode of operation - choosing *Sequential* mode to upload an image sequence that is unlimited or restricted between specified time periods, but independent of any alarm event.
8. Disconnect the camera from the network or Null Modem Cable and connect it directly to your modem.
9. Your application is complete. You should now verify the installation by accessing the images now stored with your ISP.

- Notes:**
- By configuring the AXIS 2110 to accept incoming calls, you can at any time refine or amend the product configuration remotely via a Dial-up connection - or locally, either from the Ethernet network or via a computer connected via the supplied Null Modem Cable.
 - You can refine your application using the Web-based Administration Tools.

Uploading Pre/Post Alarm Images to Your Internet Service Provider

Perfect as a remote imaging and light surveillance tool, the AXIS 2110 can not only transmit live video streams over a standard Dial-up connection, but can also be connected to a wide variety of standard external alarm devices. It can be quickly configured for uploading single images, or pre/post alarm image sequences, to a *Public* or *Private* ISP when a time or alarm-based event occurs.

Using the available Wizards, you set the times and the frequency at which images are taken and uploaded to your ISP. You can also arrange for e-mail alerts containing the alarm image buffer and a link to the camera.

Installation and Configuration Overview

Configure the AXIS 2110 to upload images to an Internet Service Provider in Alarm Mode as follows:

1. Connect the AXIS 2110 to the network if available. Otherwise, use the supplied *Null Modem Cable*.
2. Install the camera as a modem. For this and general information on the Dial-up connection, refer to *Using Your Camera with a Modem*, on page 17.
3. Refine the Dial-up parameters.
4. Initiate the Dial-up connection.
5. Referring to *Configuring Your Camera*, on page 23, open the **Home Page** in your browser and start the **Installation Wizard**. Complete the Wizard to establish the standard *Security, Date and Time, Image General Layout* and *Modem* settings - selecting **modem** as your chosen method of connection.
6. Continue the configuration using the **Application Wizard** to define your preferred ISP and mode of operation - choosing *Alarm Mode* to upload single images, or pre/post alarm image sequences, when a defined alarm or time based event occurs.
7. Disconnect the camera from the network or Null Modem Cable and connect it directly to your modem.
8. Your application is now complete. You should now verify the configuration by triggering the defined alarm event and then viewing the images uploaded to your ISP.

- Notes:**
- By configuring the AXIS 2110 to accept incoming calls, you can at any time refine or amend the product configuration remotely via a Dial-up connection - or locally, either from the Ethernet network or via a computer connected via the supplied Null Modem Cable.
 - You can refine your application using Web-based Administration Tools.

Appendix A - Lenses and Focusing

The AXIS 2110 features a replaceable CS-type Tele/Wide Zoom lens that can be targeted for different applications. Using rotational focus control, the lens must first be focused under normal, stable conditions to optimize the image quality for the camera.

The camera can be focused manually, or with the help of the **Focus Assistant**. The latter is useful if your AXIS 2110 is located remotely from your viewing workstation. Having positioned the camera, follow the instructions below to focus it.

Important!

Although the AXIS 2110 is intended for both outdoor and indoor use, it is important to note that the charged coupled device (CCD) in the camera can become permanently damaged if it is exposed to too much direct sunlight or halogen light. Therefore, it is important that the Adjustment Ring is not set fully open when installing the camera in bright light conditions. The Axis warranty does not cover CCD damage caused by prolonged exposure to strong light.

Manual Focusing

❶ Power-on the AXIS 2110 and wait 10 seconds.

❷ The Iris Adjustment Ring effectively closes and opens the camera lens to regulate the amount of light entering the camera. Closing the ring reduces the amount of light to produce a better depth of field and focus over a greater distance. Whereas, a more open lens provides better results in low-light conditions.

Rotate the Iris Adjustment Ring to an appropriate position for your chosen installation, as follows:

- indoor scene - fully open (O)
- outdoor scene - mid position (between C and O)

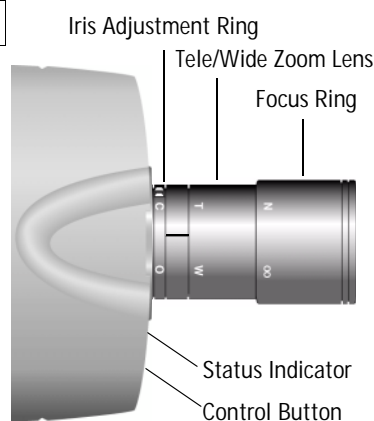

❸ Start your browser application and check the picture. Adjust the Tele/Wide Zoom Lens to a suitable position for your application.

❹ Rotate the Focus Ring to an appropriate position - until you are satisfied with the quality of the camera image.

Note: The unit is supplied with the lens set in approximate focus position, with the focus set to infinity.

Focusing using the Focus Assistant

The **Status Indicator**, used in conjunction with the **Focus Assistant**, provides an immediate visual display that will help you achieve a good basic level of focus at the point of camera installation.

Focus Quality

Once set to *Focus Mode*, the **Status Indicator** displays the following colors that represent a predefined level of focus:

Color	Level of Focus (%)	Focus Quality
Red	0 - 60	Poor
Yellow	60 - 80	Reasonable
Green	80 - 100	Good

Rotational Focus Control

The lens provided with the AXIS 2110 has rotational focus control that allows the focal length of the lens to be adjusted manually. The lens is used to establish the basic level of focus when the image is stable, that is, when there is little or no movement. Rotate the lens clockwise for close focus, or anti-clockwise for distant focus.

You will probably find that the **Status Indicator** displays green, indicating a *good* level of focus, several times during the full traverse of the lens assembly. This is because several planes of focus exist within the camera's normal field of view.

Focusing the Camera Under Stable Conditions

Before you begin:

For the focusing algorithm to work effectively, always ensure that there is minimal movement within the camera's field of view when focusing, as described below.

With reference to the illustrations, follow the instructions below to achieve a good basic level of focus under normal stable conditions:

Important!

Do not press the Control Button for at least 10 seconds after powering on the unit - as this will cause the product to return to the factory default settings.

1. Adjust the Tele/Zoom ring to the desired setting (see illustration on page 39).
2. Set the Focus Ring to its extreme far-focus position by turning it fully clockwise.
3. Rotate the Iris Adjustment Ring to an appropriate position for your installation, as follows:
 - indoor scene - fully open (O)
 - outdoor scene - mid position (between C and O)
4. Press and hold the **Control Button** using a paper clip, or any other suitably pointed object (see illustration) - until the **Status Indicator** flashes *Yellow*. This enables the Focus Assistant, sets the Status Indicator to Focus Mode, and simultaneously starts a focusing algorithm that regularly calculates the quality of focus within the camera's field of view.
5. Slowly turn the Focus Ring six full-turns counter-clockwise.
6. Finally, turn the Focus Ring slowly clockwise until the Status Indicator displays Green; that is, until a *Good* level of focus is achieved. The Status Indicator displays different colors to represent a predefined level of focus (see table below).
7. Return to your browser application and review the picture quality. Repeat step 5 only if you consider the focal distance as too distant - until you are satisfied with both the focal distance and focus quality.
8. To exit the Focus Assistant: press and hold the **Control button** until the Status Indicator **flashes Yellow**. The Status Indicator displays *Green* when the Focus Assistant is closed.

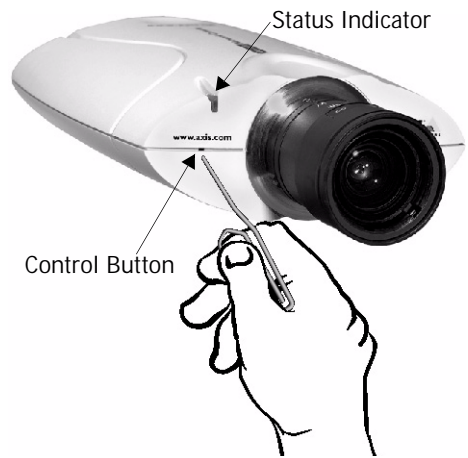

- Notes:**
- The Focus assistant can also be enabled and disabled from the **Image-Focus** page.
 - A *Good* level of focus is normally attainable throughout several planes within the camera's focusing spectrum.
 - The Status Indicator displays Green to indicate a *Good* level of focus at 80% of optimum focus.
 - Since optimum focusing is dependent on the camera's field of view, it is important to scan the focusing plane from the closest to furthest perspectives before attempting any fine-tuning.

Replacing the Lens

Because the AXIS 2110 is designed with a CS-mount, the lens supplied with your camera can be replaced with any standard CS or C lens typically used in the security/CCTV industry. Contact a security/CCTV reseller in your area for more information.

Note: Although the lens supplied with your camera can be replaced with any CS-type lens, a C-type lens must first be fitted with an adaptor for it to work with your AXIS 2110. This adapter effectively moves the lens 5mm farther from the camera.

Follow the instructions below to replace the supplied lens with any C or CS type lens:

1. Unscrew the AXIS 2110 lens.
2. *C-lens only:* Attach the *new lens* to a *CS-C Adapter*.
3. Screw the *new lens* onto the AXIS 2110. If applicable, adjust the iris according to the prevailing light conditions.
4. Referring to *Focusing the Camera Under Stable Conditions*, on page 40, adjust the camera focus.
5. Refresh your browser and check the results from the camera's **Home Page**.



Important!

Although the AXIS 2110 is intended for outdoor and indoor use, it is important to note that the charged coupled device (CCD) in the camera can become permanently damaged if it is exposed to too much direct sunlight, or halogen light. Therefore, it is important that the Adjustment Ring is not set fully open when installing the camera in bright light conditions. The Axis warranty does not cover CCD damage caused by prolonged exposure to strong light.

Tip! When mounting the camera behind glass, make sure that the camera lens is not too far away from the glass - particularly when installing the unit in an outdoor enclosure. This will help reduce undesirable reflections in the image.

The lens rotates on a screw fitting and can be completely removed. If you do need to remove the lens, take care not to let any dust enter the lens or the camera window - as this can adversely affect the quality of your live images.

Appendix B - Troubleshooting

This appendix provides useful information on solving problems you might have with your AXIS 2110.

Frequently Asked Questions

Q: Which modem should I select in the list on the Modem Settings page if mine is not listed?

A: *Generic.*

Q: Do I have to use one of the listed ISPs on the ISP Settings page?

A: *No. You can make whatever settings you like for your own ISP. You can use the name "Generic" for your own settings.*

Q: When should I use the Null Modem Cable?

A: *This cable is only intended as an alternative for configuring your camera when there is no network available.*

Q: Can I set up my camera to run as a PC-cam on my computer?

A: *No. The AXIS 2110 is a network camera for use only on Ethernet networks or with a modem.*

Q: Do I have to use the Wizards whenever I want to make changes?

A: *No. Everything which is configured in the Wizards can also be configured individually from the links on the left hand side of the Administration Tools page.*

Q: What are the ftp-path, the ftp-host name and ftp-user name?

A: *If you are uploading your images to an ftp-server, the ftp-path is the location of the directory on the remote ftp-server where you will be saving your images, the ftp-host is the name or IP-address of the ftp-server and the ftp-user name is the identity you use for logging in to the ftp-server.*

PINGing Your IP Address

By sending a packet to the specified address and waiting for a reply, the *PING* utility can determine whether a specific IP-address is accessible. It also provides a particularly useful method for confirming addressing conflicts with your AXIS 2110 on the network.

Follow the instructions below in association with *Problems, Possible Causes and Remedial Actions*, on page 45, and run the PING utility to troubleshoot TCP/IP problems on your network:

1. Disconnect your AXIS 2110 from the network.
2. Start a DOS window.
3. Type `ping x.x.x.x`, where *x.x.x.x* is the IP address of the AXIS 2110.

The subsequent replies as shown in the table below will provide an explanation as to the cause of the problem:

PING Reply	Interpretation and recommendation
bytes = 32 time = 2 ms.....	The IP address is already used and cannot be used again. You must obtain a new IP address.
destination host unreachable	The AXIS 2110 is not accessible within your subnet. You must obtain a new IP address.
request timed out	This IP address is not used by anyone and is available for use with your AXIS 2110.

Problems, Possible Causes and Remedial Actions

Symptoms	Possible causes	Remedial actions
The AXIS 2110 cannot be accessed from a browser.	The IP address is already used by another device.	<p>Disconnect your AXIS 2110 from the network.</p> <p>Run the PING utility (as described in <i>PINGing Your IP Address</i>, on page 44) and follow the appropriate recommendations.</p> <p>Note: The assigned IP number can be assumed valid if the PING utility returns "request timed out" - in which case you should set the IP address again, power on the AXIS 2110 and then try accessing the unit again.</p>
	The IP address is located on a different subnet.	<p>Run the PING utility (as described in <i>PINGing Your IP Address</i>, on page 44). If the utility returns "no response" or similar, the diagnosis is probably correct - you should then proceed as follows:</p> <p>In Windows 95/98 or Windows NT/2000, check that the IP address for your AXIS 2110 is on the same subnet as your workstation:</p> <p>Click "Start", "Settings", "Control Panel" and "Network".</p> <p>Specify the TCP/IP adapter and click on "Properties". In Properties, click "IP Address".</p> <p>If your AXIS 2110 is on a different subnet than your workstation, you will not be able to set the IP address from this workstation. Please contact your network administrator.</p>
	In Windows 95, the ARP table was empty when you tried to set the IP address.	<p>If the table is empty, re-install the product ensuring that the IP address for your own PC is also used. Type <code>arp -a</code> to view the ARP table.</p> <p>Note: The AXIS IP Installer provides a good alternative to ARP.</p>
	Possible problem with your proxy server.	Try disabling the proxy default in your browser.
	Other networking problems.	<p>Try replacing your network cable.</p> <p>Test the network interface of the product by connecting a local computer to the unit, using a standard <i>Crossover (hub-to-hub) Cable</i>.</p> <p>If the above actions don't solve the problem, the AXIS 2110 may be faulty. In this case, try to localize the problem by connecting the AXIS 2110 to the serial port of a local computer, using the supplied <i>Null Modem Cable</i>; and report your findings to your local distributor.</p>
	No access via modem connection.	Incorrect settings.
Bad connection.		Check all cables and ensure that the phone line is working.
Faulty modem.		Check the modem.

Symptoms	Possible causes	Remedial actions
No access via the Null Modem Cable.	Incorrect modem/dial-up settings.	Check the settings, especially the ports and the communication speed.
	Incorrect use of the cable.	The null modem cable is not intended for use as a serial connection for the AXIS 2110, i.e. it cannot be used to run the AXIS 2110 as a "PC camera".
The Power indicator is not constantly lit.	Faulty power supply.	Verify that you are using an AXIS PS-D power supply.
The Network indicator displays red.	Faulty cabling.	To verify that the cables are functional, PING the address of a known unit on your network. If the cabling is OK and your network is reachable, you should receive a reply similar to this: <code>...bytes = 32 time = 2 ms,</code>
The Active and Network indicators are flashing every 0.5 seconds.	Hardware failure.	Contact your Axis dealer.
Your AXIS 2110 works locally, but not externally.	Firewall protection	Check the Internet firewall with your system administrator.
	Default routers required	Check if you need to configure the default router settings.
	The Internet site is too heavily loaded.	Configure the AXIS 2110 to upload your video images to an FTP server or an ISP.
No image using Refresh and/or slow updating of images.	Requests for images of varying size and resolution place a greater demand on the available file space within the AXIS 2110.	Ensure that all the clients accessing the images are using the same image resolution and compression. For large numbers of clients, configure the AXIS 2110 to upload your images to an FTP server or an ISP.
A series of broad vertical white lines appears across the image.	The CCD sensor becomes overloaded when the light is too bright. This can happen e.g. with sunlight reflexes.	Although the AXIS 2110 is suitable for outdoor use, direct exposure to extreme sunlight or halogen light may nonetheless cause serious damage to the CCD sensor. Reposition your AXIS 2110 in a more shaded location immediately. Note: damage caused to the AXIS 2110 through over-exposure to direct sunlight or halogen light is not covered under the product warranty.
Bad focus.	Focus has not been correctly adjusted.	Referring to the on-line help, adjust the White Balance setting and then try resetting the camera focus again using the <i>Focus Assistant</i> , as described in <i>Lenses and Focusing</i> , on page 39.
	No adaptor fitted with your C-type lens.	If you have previously replaced the supplied CS-type lens, you may have inadvertently installed a C-type lens without first fitting the required adaptor. See also page 42.

Symptoms	Possible causes	Remedial actions
Noisy images.	Video images may be noisy if you are using the AXIS 2110 in a very low light environment.	To solve this problem, you need more light. The performance of the camera is best in 100 - 3.000 lux. You may wish to consider replacing the basic lens with a more sensitive lens (Lower F-number), if the lighting conditions within the installation area cannot be improved.
Poor quality images.	The display properties are incorrectly configured for your desktop.	Open the Display Properties in your desktop and configure your display to show at least 65 000 colors, i.e. at least 16-bit. Note: Using only 16 or 256 colors on your computer will produce dithering artifacts in the image.
No images available in your browser application.	ActiveX disabled.	If you are using Microsoft Internet Explorer, ensure that ActiveX has not been disabled in the Internet Options menu. Alternatively, use the Java Applet for viewing images.

Note: If you still have a problem after reading this information, please contact your reseller or check the AXIS 2110 product pages on the Axis Website at www.axis.com.

Appendix C - Updating the Software

The AXIS 2110 camera software is stored in Flash memory. This memory is provided by a silicon chip that, just like any other ROM device, retains data content even after power is removed. Flash memory is unique because it allows its data to be erased and re-written. This means you can install software updates for your AXIS 2110 as they become available - without having to replace any parts. New software can be simply loaded into the AXIS 2110 over the network.

Obtaining Updated Software

The latest version of the AXIS 2110 software is available free of charge from the Axis Website at www.axis.com, or from your local distributor.

Upgrading the Software

The AXIS 2110 Flash memory is upgraded over the network using FTP. See the detailed instructions supplied with each new software release.

Important!

- Always read the upgrade instructions available with each new release, prior to upgrading your software.
- Downloading normally takes between 30 seconds and 10 minutes, although it can take longer. After starting the download, you should always wait at least 20 minutes before power cycling the AXIS 2110 - even if you suspect the download procedure has failed.
- In controlled environments, flash memory upgrades provide a very safe method for updating software. However, flash products can become damaged if the upgrade operation is not performed correctly. Your dealer reserves the right to charge for any repair attributable to faulty upgrading by the user.

Appendix D - The Unit Connectors

This section provides a detailed overview of the two supported product connectors: the **Serial Connector** and the **IO Connector**. It also includes connection diagrams for simple door switch and an LED output, as well as a more complete schematic diagram describing how the AXIS 2110 is connected for a typical application.

The Serial Connector

In the absence of a local network connection, the RS232 serial connector provides a physical interface for connecting a modem or computer to the AXIS 2110. This means that the AXIS 2110 can operate as a standalone unit - independent of any computer network. When a local network connection is unavailable at the point of installation, connect your PC to this connector using the supplied *Null Modem Cable* to initially configure your product.

The Physical Connector

A single 9 pin D-sub connector provides the physical connection for the RS232 serial interface of the AXIS 2110. This connector is dedicated for use with an external modem and is suitable for speeds up to 115kbps.

A diagram of the RS232 connector's pinout information is shown below.

Pin	Function
1	CD (Carrier Detect)
2	RXD (Receive Data)
3	TXD (Transmit Data)
4	DTR (Data Terminal Ready)
5	GND (Ground)
6	DSR (Data Signal Ready)
7	RTS (Return To Send)
8	CTS (Clear To Send)
9	RI (Ring Indicator)

A view of the RS232 Serial Port from the rear of the AXIS 2110

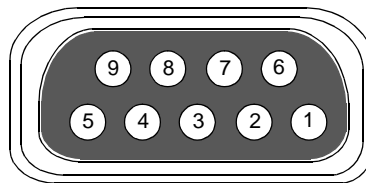

The IO Connector

A 4-pole connector is provided for auxiliary IO connections to the AXIS 2110.

Physical Connector

The IO connector provides the interface to a single digital output and a single digital input. A diagram for the connector complete with a pinout table is provided below.

Pin	Function
1	Common Ground
2	Positive Connection for DC Power Input or Output: Electrically in parallel with the derived DC power for the unit, this pin may be used as a power input or output. As a power input it can be used for remote applications to supply the AXIS 2110 via an external direct current source; for example, a 9-15V DC battery supply. Used as a power output, it can drive the photo coupled input or other equipment; such as an infrared sensor. The output voltage level is dependent upon the input voltage to the unit. A maximum current of 50mA can be sourced from the DC output.
3	Digital Input (photo-coupled anode on the diode): Voltages 5-24V DC will activate the input. It is possible to use pin 2 to source the input.
4	Digital Transistor Output: With a maximum load of 100mA and a maximum voltage of 24V DC, this output has an open-collector NPN transistor with the emitter connected to pin 1. If it is to be used with an external relay, a diode must be connected in parallel with the load for protection against any voltage transients - as detailed in the <i>Schematic Connection Diagram of the I/O and RS232 Connector</i> , on page 53. Note: Connecting AC to the transistor output will damage the unit.

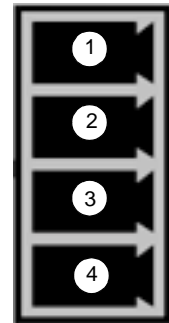

Digital Input

Used for connecting external alarm devices and triggering images for specific alarm-based events, the digital input is typically connected to a motion detector - or any other external security device - for taking images on each occasion the detector is activated.

Digital Output

The supported transistor output can drive a maximum load of 24V DC at 100mA directly, and by connecting additional relay circuitry, it can drive even heavier loads.

Using the **Administration Tools**, you must first enable **IO Status** in the **Layout Settings** for the Digital Output **ON/OFF** buttons to be displayed in the product **Home Page**. The status of the Digital Output is then controlled by simply clicking these buttons.

Connection Diagram for a Simple Door Switch

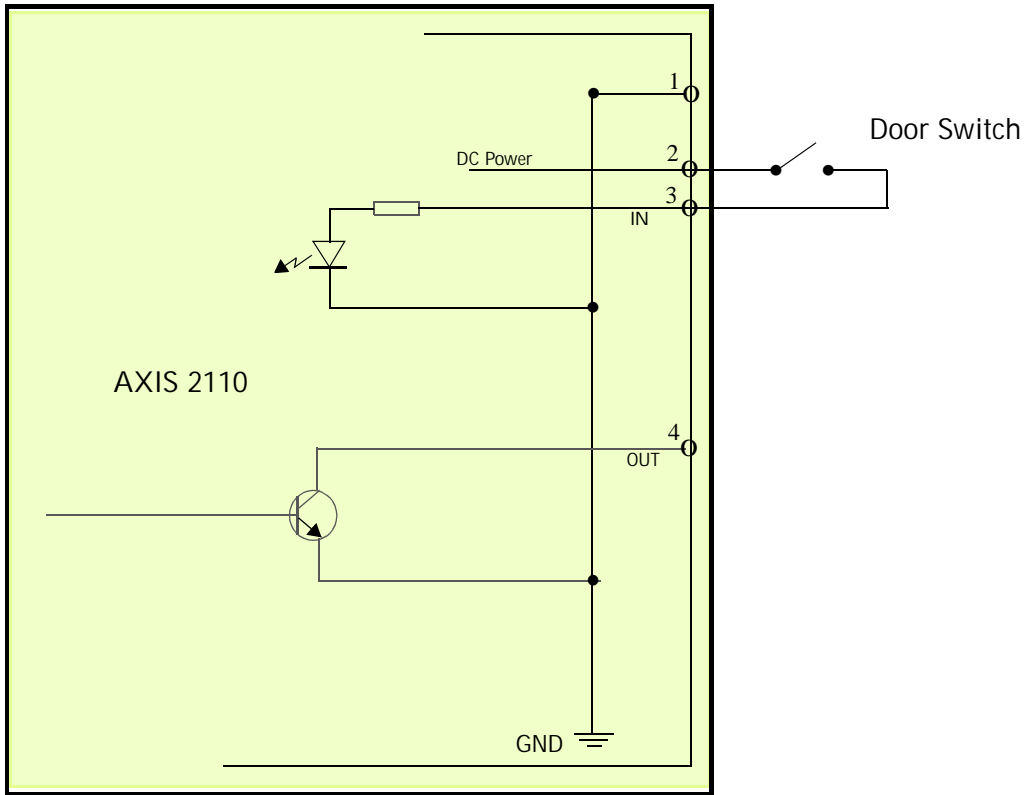

Connection Diagram for an LED indicator Output

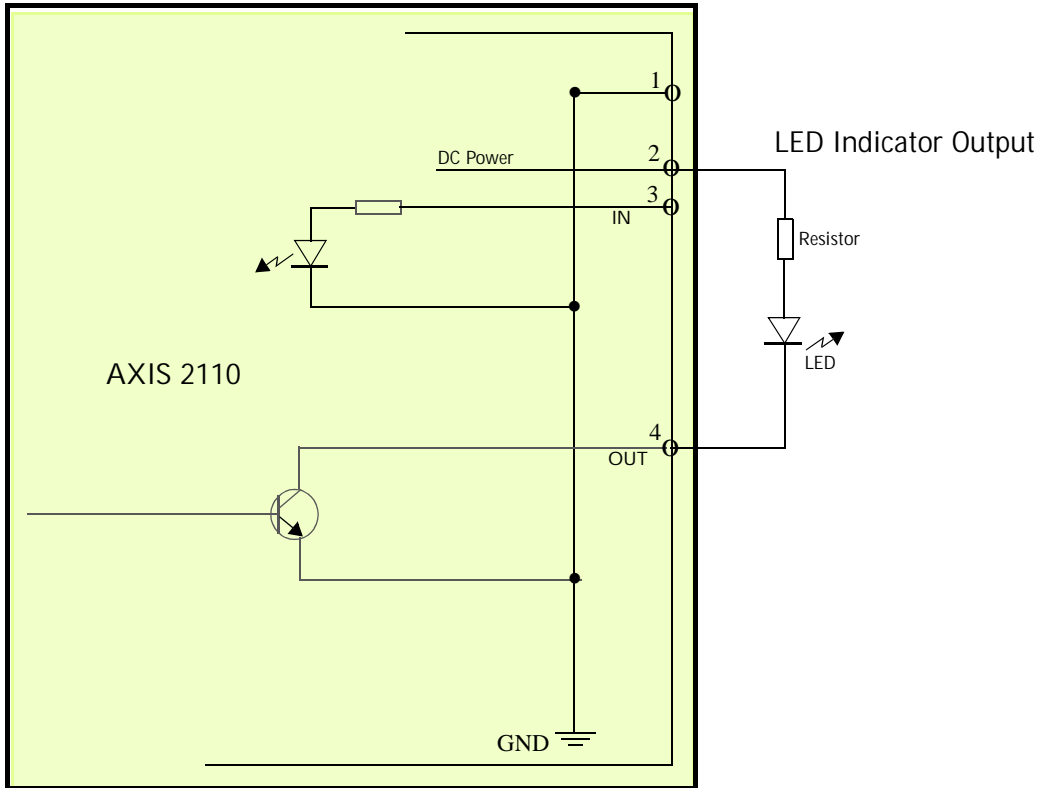

Schematic Connection Diagram of the I/O and RS232 Connector

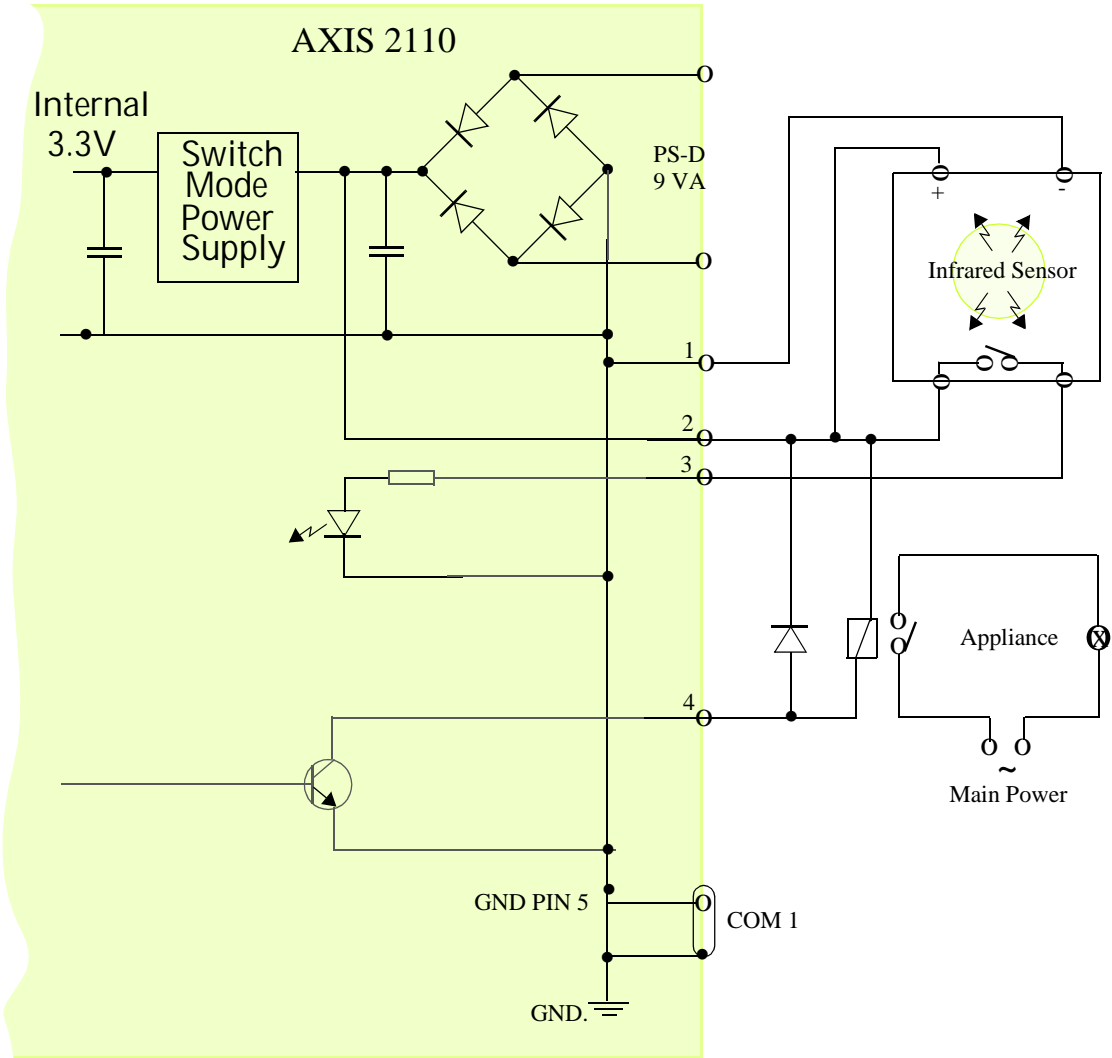

Pins 1 and 2 are connected to the derived DC power for the unit, and can be used as an external power feed for external equipment; such as an Infrared sensor. When connecting other equipment using this connector, the maximum current of 50mA must be strictly observed. Failure to do so may cause a loss of power to the unit and may even damage your camera.

Appendix E - High Speed Services

You will experience the full performance of the AXIS 2110 if you have access to high speed Internet services; such as, xDSL or a cable modem connection. However, as most high speed Internet services only provide you with one external IP address, there are several practical issues that should be considered when developing your application.

Available IP Addresses

Ideally, your ISP (Internet Service Provider) will provide you with several external static IP addresses - in which case you can assign any one of these to your AXIS 2110 to make it fully accessible over the internet. However, if your service provider supplies you with only one IP number - which is often the case - this IP number is normally assigned to your PC - leaving no connection available for your AXIS 2110. So, what can you do if your ISP is unable to provide you with an additional IP number? Fortunately, there are a number of other options that you may like to consider; including:

NAT Box

Short for Network Address Translation, NAT is an Internet standard that allows a local-area network (LAN) to use one set of IP addresses for internal traffic and a second set of addresses for external traffic. A NAT box located where your LAN meets the Internet will handle all of the necessary IP address translations and provides:

- Internal IP addresses that are unique to your network - with no possibility of conflict with IP addresses used by other companies and organizations.
- The possibility of combining multiple ISDN connections into a single Internet connection.
- An effective firewall for hiding internal IP addresses

NAT Feature in Windows 2000

Utilize the NAT feature in Windows 2000 to allow multiple Ethernet cards in your PC, and you can then use one port for the internet and the other for your internal network. With this solution, you can let your AXIS 2110 upload image streams to an external Web server that is maintained and located with your ISP.

Note: For further details on Network Address Translation, see also RFC 1631.

Routers and Firewalls

Another ideal solution is to use one of several small routers/firewalls currently available on the market. This provide the necessary NAT functionality and allow complete independence for your PC, which can be switched off or rebooted without effecting the image transmission from your AXIS 2110.

WinGate Server Software:

Running on a single Windows 95/98/2000 or NT computer, this software allows multiple users simultaneous access to the Internet through a single modem; ISDN; or high speed line, such as xDSL or cable modem connection; and effectively shares a single Internet connection with almost any type of client computer running TCP/IP.

For more advanced users, the WinGate 3.0 Standard and Pro versions also allow the administrator to change the IP bindings so that external requests may be routed specifically to your AXIS 2110 - running behind the WinGate software.

Appendix F - Technical Specifications

System Requirements - TCP/IP on Windows 95, 98, NT and 2000, as well as Linux, UNIX, Mac and several others. Microsoft Internet Explorer 4.x, or higher (used with Axis' ActiveX component AXIS Camera Control), or Netscape 4.x or higher.

Network Connection - RJ45 twisted pair cable, or remote connection using any standard serial modem.

Networking - 10baseT Ethernet or 100baseTX Fast Ethernet, TCP/IP, HTTP, FTP, SMTP, NTP, ARP and BOOTP.

I/O Connector - 1 optical-isolated alarm input. 1 digital output (max 24V, 100mA) with programmable digital input/output for remote image storage via FTP or SMTP, pre/post alarm image storage.

Image Updating - Up to 15 frames/second over 10Mbps or 100Mbps networks.

Pre/Post Alarm Buffer - Up to 500kB memory available for pre/post alarm image storage.

Modem Connector - Single 9-pin D-SUB RS-232 connector, max 115 kbps, half duplex

Operating Conditions: - Temp: 40^o to 105^o F (+5^o to +40^o C), Humidity: 20-80% RHG.

Approvals - EMC: FCC Class A, **CE** EN 55022/1994, EN55024/1998
Safety: EN 60950, UL, CSA.

Metrics: - Height: 1.6" (4.0 cm), Width: 4.1" (10.5 cm), Length: 6.9" (17.5 cm), Weight: 0.56 lb. (0.26 kg) excluding power supply.

Hardware - ARTPEC-1 compression chip; ETRAX-100, including, 32 bit RISC, 100 MIPS CPU, 8 MB RAM, 2 MB FLASH PROM.

Power - External power supply 12V AC, 9.6 VA (PS-D, included), 9-15V AC, min. 10VA, or 9-15V DC, min. 7W.

Index

- A**
Access rights 27
 Admin 27
 Dial-in 27
 View 27
Administration Tools 25
Anonymous user access 27
AppleTalk 16
ARP 45
ARTPEC-1 56
AXIS IP Installer 13
- B**
Boa Web server 6
BOOTP 13, 15
- C**
CGI scripts 5
Compression 5, 30
Configuring 23
Connectors 49
- D**
DHCP 14
Dial-up Networking 20
Digital input 50
Digital output 50
- E**
E-mail 5
Ethernet 5
Ethernet address 13
ETRAX-100 56
- F**
Factory Default Settings 28
Fast Ethernet 5
File sizes 30
Firewalls 55
- Focus Assistant 40
Focus Mode 40
Focus Quality 40
- H**
Home page 12
HTTP 5
- I**
I/O Connector 8
Installation 10
Internet address 45
- J**
JPEG 5
- L**
Lighting conditions 30
Linux 6, 56
- M**
Macintosh users 16
Mounting assembly 9
- N**
Network Address Translation 54
Network Connector 8
Network Indicator 8
Network indicator 46
Network installation 10
Null Modem Cable 17, 19
- O**
Obtaining updated software 48
- P**
performance 6
Power indicator 46
Power supply connector 8
PPP 6
problems 43, 49

R

Resolution 30

Routers 55

RS232 connector 8
 diagram 49

S

Serial number 7

SMTP 5

Status Indicator 40

T

technical specifications 56

triggering images 50

troubleshooting 43, 49

W

WinGate 55

X

xDSL 54

Glossary of Terms

ActiveX - A control (or set of rules) used by a browser. ActiveX controls are often downloaded and installed automatically as required.

ARP - Address Resolution Protocol. A protocol for assigning an IP address to a physical device address that is recognized in the local network. The ARP command can be used to set the IP-address for your product.

ARTPEC - Axis Real Time Picture Encoder - used for image compression.

BOOTP - A protocol that can automatically configure a network device (give it an IP address).

Bps - Bits per second. A unit for measuring speeds in networks. A LAN might run at 10Mbps or 100Mbps.

CCD - Charged Coupled Device. This is the camera component that converts the image to digital signals.

CGI - Common Gateway Interface. A set of rules (or a program) that allows a Web Server to communicate with other programs.

CS-Mount/C-Mount - Industry standards defining types of lens fittings. The CS-Mount positions the lens approx. 5mm further from the CCD than the C-Mount does.

DSL - Digital Subscriber Line. A means of transferring data via standard phone lines.

Ethernet - A widely used networking standard.

ETRAX - Axis' own microprocessor.

Firewall - A virtual barrier between a LAN (Local Area Network) and other networks, e.g. the Internet.

Frame Grabber card - Plug-in hardware for "grabbing" images

FTP - File Transfer Protocol. Used for simple transfer of files to and from an ftp-server.

HTML - Hypertext Mark-up Language. Used widely for authoring documents viewed in web browsers.

HTTP - Hypertext Transfer Protocol. The set of rules for exchanging files (text, images, sound, video, and other files) on the World Wide Web.

Intranet - A private network limited to an organisation or corporation. Usually closed to external traffic.

IP - Internet-Protocol. See TCP/IP.

IP number (address) - A unique number used by a computer on the network to allow it to be identified and found.

JPEG - A standard image format, used widely for photographs. Also known as JPG.

LAN - A local area network (LAN) is a group of computers and associated devices that typically share common resources within a limited geographical area.

Linux - A popular operating system, that is "open source" and practically free of charge.

Lux - A standard unit for light measurement.

NWAY - A network protocol that automatically negotiates the highest possible common transmission speed between two devices.

Null Modem Cable - A cable used for connecting a PC to a serial device, using the modem protocol for communication.

PING - A small utility used for sending data packets to network resources to check that they are working and that the network is intact.

PPP - Point-to-Point Protocol. A method allowing one computer to connect to another, usually via a modem over a phone line.

Pre/post alarm image - The images from immediately before and after an alarm.

Protocol - A special set of rules governing how two entities will communicate. Protocols are found at many levels of communication, and there are hardware protocols and software protocols.

SMTP - A common e-mail protocol.

TCP/IP - Transmission Control Protocol/Internet Protocol. A suite of network protocols that determine how data is transmitted. TCP/IP is used on many networks, including the Internet. TCP keeps track of the individual packets of information and IP contains the rules for how the packets are actually sent and received.

URL - Uniform Resource Locator. An "address" on the network.

V.90 - An operating standard for telephone modems.

WAN - Wide-Area-Network. Similar to a LAN, but on a larger geographical scale.

Web server - A program on a computer that delivers the resources (usually web pages) requested by the web user (the client).

Wizard - A program designed specifically to guide the user through a procedure. Typically used for installations and configurations.